

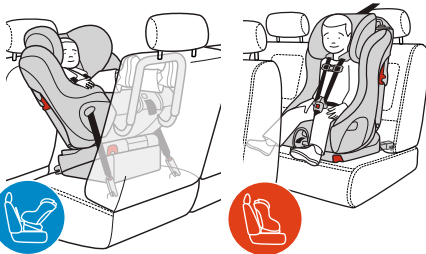

dek

Foonf Instruction Manual

This car seat is designed for use either Rear-Facing or Forward-Facing by children who meet all of the following requirements:



WARNING

- Read and understand product labels and all instructions in this manual and in your vehicle owner's manual before installing or using this car seat.
- Failure to properly install or use this car seat or follow these warnings and those on this car seat's labels can result in serious injury or death to the child in a sharp turn, sudden stop or crash.



HEIGHT

25 – 43 in.
64 – 110 cm

WEIGHT

14 – 50 lb
6.4 – 22.7 kg

AGE

Able to sit
upright alone



HEIGHT

30 – 49 in.
76 – 124 cm

WEIGHT

20 – 65 lb
9.1 – 29.5 kg

AGE

2+ years
recommended
(1 year min.)

Checklist for Proper Use

IMPORTANT: This is only a checklist — you must read and understand all of the warnings and instructions on this car seat’s labels and in this manual before installing or using this car seat.



When Using This Car Seat in Rear-Facing Mode

- ✓ Child weighs between 14 and 50 lb (6.4 and 22.7 kg), height is between 25 and 43 in. (64 and 110 cm) and able to sit upright alone.
- ✓ Car seat is securely installed in a vehicle rear seat using Rear-Facing Base with the Anti-Rebound Bar properly secured.
 - If car seat must be installed in a front seat, the front air bag for that position is deactivated and the vehicle owner’s manual states that this is an acceptable position to install a Rear-Facing child restraint.
- ✓ LATCH lower anchor belt or Vehicle Belt is correctly routed under Seat Cushion in the Rear-Facing belt path and there is no slack in the LATCH lower anchor belt or the Vehicle Belt.
 - If child weighs more than 25 lb (11.4 kg), this car seat must be installed with a Vehicle Belt.
- ✓ Car seat is reclined within an acceptable recline zone for the child’s age using a Rear-Facing recline position.
- ✓ The top of the child’s head is at least 1” (2.5 cm) below the top of the car seat Headrest.
- ✓ Shoulder Harness Straps **MUST** be through Shoulder Harness Slots closest to and at or below the shoulder of the child.
- ✓ Bottom of Headrest is at or above the Shoulder Harness Slots in use.
- ✓ Crotch Belt is through Crotch Strap Slot at or behind and closest to the child’s crotch.
- ✓ Harness is snugly adjusted on child and buckled.



When Using This Car Seat in Forward-Facing Mode

- ✓ Child weighs between 20 and 65 lb (9.1 and 29.5 kg), height is between 30 and 49 in. (76 to 124 cm) and is at least 1 year of age.
- ✓ Car seat is securely installed in a vehicle rear seat without the Rear-Facing base or the Anti-Rebound Bar.
 - If car seat must be installed in a front seat, the front air bag for that position is deactivated, check the vehicle owner’s manual for proper use of a child restraint in that position.
- ✓ Car seat is correctly attached to the vehicle using either the rigid LATCH lower connectors and the Top Tether; a Vehicle Belt and the Top Tether; or the rigid LATCH lower connectors, a Vehicle Belt, and the Top Tether.
 - If child weighs more than 35 lb (15.9 kg), this car seat must be installed either with a Vehicle Belt and the Top Tether or with the rigid LATCH lower connectors, a Vehicle Belt, and the Top Tether.
- ✓ Car seat is in a Forward-Facing recline position.
- ✓ The top of the child’s ears are at or below the top of the car seat Headrest.
- ✓ Shoulder Harness Straps **MUST** be through Shoulder Harness Slots closest to and at or above shoulders of child.
 - If seat is installed with a lap belt, Shoulder Harness Straps are through one of the top two sets of Shoulder Harness Slots.
- ✓ Bottom of Headrest is at or above the Shoulder Harness Slots in use.
- ✓ Crotch Belt is through Crotch Strap Slot at or behind and closest to the child’s crotch.
- ✓ Harness is snugly adjusted on child and buckled.

For concerns related to parts or the use and maintenance of this product, please contact us at:

Clek Inc.
Attn: Customer Service
226 Lesmill Road
Toronto, Ontario
Canada
M3B 2T5

www.clekinc.com

Table of Contents

| | |
|---|-----------|
| Checklist for Proper Use | i |
| When Using This Car Seat in Rear-Facing Mode | i |
| When Using This Car Seat in Forward-Facing Mode | ii |
| Car Seat Features | 3 |
| Registration & Recall Information | 5 |
| Registering Your Car Seat | 6 |
| Warnings | 7 |
| Certification | 12 |
| Size & Age Limitations | 12 |
| When Using This Car Seat in Rear-Facing Mode | 13 |
| When Using This Car Seat in Forward-Facing Mode | 15 |
| Vehicle Information | 17 |
| Vehicle Child Restraint Anchorage System (LATCH) | 17 |
| Vehicle Seat Location Requirements | 18 |
| Vehicle Belt Requirements | 20 |
| Vehicle Belt Systems | 21 |
| Before Installing Car Seat | 24 |
| Rear-Facing | 24 |
| Forward-Facing | 25 |
| Installing/Removing Rear-Facing Car Seat | 25 |
| Installing Rear-Facing Car Seat With LATCH | 27 |
| Removing Rear-Facing Car Seat Installed With LATCH | 33 |
| Installing Rear-Facing Car Seat With Vehicle Belt | 35 |
| Removing Rear-Facing Car Seat Installed With Vehicle Belt | 42 |
| Installing/Removing Forward-Facing Car Seat | 43 |
| Installing Forward-Facing Car Seat With LATCH | 44 |

| | |
|--|------------|
| Removing Forward-Facing Car Seat Installed With LATCH | 55 |
| Installing Forward-Facing Car Seat With Vehicle Belt | 57 |
| Removing Forward-Facing Car Seat Installed With Vehicle Belt | 63 |
| Securing Your Child in Car Seat | 65 |
| Removing Your Child From Car Seat | 70 |
| Operation and Adjustments | 71 |
| Crotch Strap Adjustment | 71 |
| Shoulder Harness Height Adjustment | 73 |
| Shoulder Harness Unthreading | 74 |
| Shoulder Harness Slot Adjustment | 75 |
| Shoulder Harness Rethreading | 76 |
| Shoulder Harness Cover Removal/Installation | 79 |
| Installing/Removing Rear-Facing Base | 80 |
| Installing/Removing Rear-Facing Anti-Rebound Bar | 81 |
| Removing/Installing Seat Cushion | 84 |
| Installing/Adjusting Headrest | 86 |
| Rear-Facing LATCH storage | 88 |
| Forward-Facing Rigid LATCH Storage | 90 |
| Top Tether Storage | 90 |
| Instruction Manual Storage | 91 |
| Removing/Installing Seat Cushion Cover | 91 |
| Aircraft Installation | 93 |
| Care and Cleaning | 94 |
| Troubleshooting | 97 |
| Accessories | 97 |
| Warranty | 98 |
| How To Receive Spanish Instructions | 100 |
| Cómo recibir las instrucciones en español | 100 |

Car Seat Features – Front

- 1 Seat Cushion
- 2 Shoulder Harness Slots
- 3 Shoulder Harness Covers
- 4 Shoulder Harness Straps
- 5 Chest Clip
- 6 Buckle Tongues
- 7 Buckle
- 8 Crotch Strap
- 9 Buckle Pad
- 10 Harness Adjuster
- 11 Harness Adjuster Strap
- 12 Recline Handle
- 13 Rigid LATCH Release Handles
- 14 Rigid LATCH Adjustment Handle
- 15 Rear-Facing Belt Path
- 16 Headrest
- 17 Headrest Adjuster
- 18 Crotch Strap Slots
- 19 Rear-Facing LATCH Storage (under Seat Cushion)
- 20 Rear-Facing LATCH Belt
- 21 Rear-Facing LATCH Push-on Connectors
- 22 Rear-Facing Belt Lock-offs

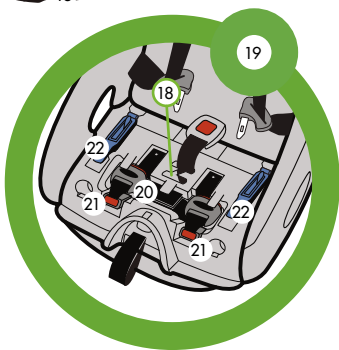

Car Seat Features – Back

- 23 Seat
- 24 Top Tether
- 25 Tether Adjuster
- 26 Tether Hook
- 27 Tether Storage (behind manual)
- 28 Forward-Facing Shoulder Belt Lock-offs
- 29 Shoulder Harness Access Panel
- 30 Troubleshooting Tool
- 31 Shoulder Harness Straps
- 32 Metal Harness Plate
- 33 Rigid LATCH Lower Connectors (Forward-Facing Use)
- 34 Yellow and Black Rigid LATCH Label (NEVER use without Top Tether while visible)
- 35 Instruction Manual (stored in Shoulder Harness Access Panel)
- 36 Rear-Facing Base
- 37 Rear-Facing Base Retention Hooks
- 38 Rear-Facing Base Release Lever
- 39 Anti-Rebound Bar
- 40 Anti-Rebound Bar Locking Pins and Locking Pin Clips

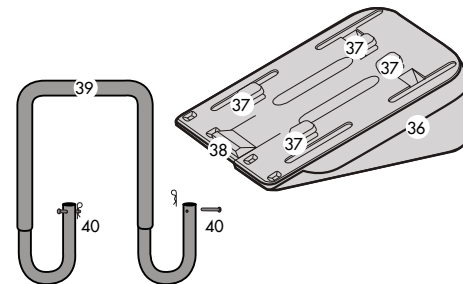
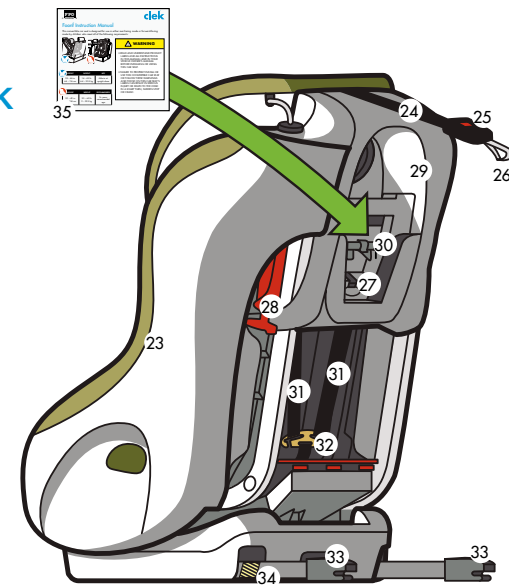

Registration & Recall Information



WARNING

- Child restraints could be recalled for safety reasons. You must register this restraint (car seat) to be reached in a recall.

Model Name: **FOONF** _____

Serial Number: _____

Manufactured In: _____
(yyyy/mm/dd)

Date of Purchase: _____

Registering Your Car Seat

Please fill in the information on the previous page for your records. The model name, serial number and manufacturing date can be found on a label affixed to the back of this Car Seat.

Fill out the prepaid registration postcard attached to the car seat and mail it today.

Child restraints could be recalled for safety reasons. You must register this restraint to be reached in a recall. Send your name, address, e-mail address if available, and the restraint's model number and manufacturing date to:

Clek Inc.
226 Lesmill Road
Toronto, Ontario, Canada M3B 2T5

or call 1-866-656-2462

or register online at <http://www.clekinc.com/register>

For recall information, call the U.S. Government's Vehicle Safety Hotline at 1-888-327-4236 (TTY: 1-800-424-9153), or go to <http://www.NHTSA.gov>.

Warnings

WARNING – DEATH or SERIOUS INJURY can occur

Failure to properly install or use this car seat or follow these warnings and instructions and those on this car seat's labels can result in serious injury or death of the child in a sharp turn, sudden stop or crash.

- Do not install or use this car seat until you read and understand the instructions in this manual and in your vehicle owner's manual. Do not let others install or use this car seat unless they understand how to correctly install and use it.
- Never use this car seat Rear-Facing in a vehicle front seating location with an air bag.
- Use only with children who weigh between 14 and 65 lb (6.4–29.5 kg) and whose height is 49 in. (124 cm) or less and who are capable of sitting upright alone.
- Use only in a Rear-Facing position when using this car seat with an infant less than one year old and weighing less than 20 lb (9.1 kg).
- Failure to choose the correct car seat mode (Rear-Facing or Forward-Facing) and to properly secure this car seat and your child can increase the risk of injury or death.

WARNING – DEATH or SERIOUS INJURY can occur (continued)

- Never use this car seat with children not able to sit upright alone. Their head may fall forward, which could restrict their ability to breathe.
- Discontinue Rear-Facing use when:
 - Child's weight exceeds 50 lb (22.7 kg).
 - Child's height exceeds 43 in. (110 cm).
 - Child's head is less than 1" (2.5 cm) from top of Headrest in highest position.
- Discontinue Forward-Facing use when:
 - Child's weight exceeds 65 lb (29.5 kg).
 - Child's shoulders are above the top Shoulder Harness Slots.
 - Top of child's ears are above the top of the car seat's Headrest in its highest adjustment position.
- This car seat must be installed by an adult.
- Never allow the child to buckle themselves in this car seat.
- Snugly adjust harness provided with this car seat around child.
- Always use the Buckle Pad supplied with this car seat for children weighing up to 22 lb (10 kg).

 **WARNING – DEATH or
SERIOUS INJURY can occur (continued)**

- Never use this child restraint Rear-Facing without the Rear-Facing Base and Anti-Rebound Bar.
- Never secure car seat into vehicle with a belt around the base. Belt must always be routed through the correct Belt Path in the seat for the mode of use (denoted by blue markings for Rear-Facing and red markings for Forward-Facing).
- Never use this seat without the Headrest.
- Do not use this child restraint with motorized or door mounted belt systems.
- Secure this child restraint with the vehicle's LATCH system or with a vehicle belt and Top Tether as shown in this manual.
- LATCH system or vehicle belt must stay tightly adjusted on car seat at all times.
- When using this car seat in Rear-Facing mode with a child weighing more than 25 lb (11.4 kg), this car seat must be installed with a Vehicle Belt.
- When using this car seat in Forward-Facing mode with a child weighing more than 35 lb (15.9 kg), this car seat must be installed with:
 - the LATCH lower anchors, a Vehicle Belt and the Top Tether; or
 - a Vehicle Belt and the Top Tether

 **WARNING – DEATH or
SERIOUS INJURY can occur (continued)**

- LATCH lower anchors and Top Tether and Vehicle Belt can be used in combination up to 65 lb (29.5 kg) in Forward-Facing Mode only.
- NEVER use this car seat, when installed with Rigid LATCH, while the Yellow and Black Rigid LATCH Label is visible unless the Top Tether is attached as instructed in this manual.
- ALWAYS secure the Top Tether provided with this car seat when installing Forward-Facing with Rigid LATCH or a lap belt. NEVER use this car seat, when installing Forward-Facing with Rigid LATCH or a lap belt, without the Top Tether.
- ALWAYS secure the Top Tether provided with this car seat when installing Forward-Facing with lap/shoulder belt unless no Top Tether anchorage is available.
- Do not use this car seat after a crash of any kind. A crash can cause damage to this car seat that you cannot see.
- Always securely attach this car seat to the vehicle, even when not occupied. An unsecured car seat can injure other occupants in a crash.
- Never leave child unattended.
- Never leave child in car seat when Harness is not buckled and properly adjusted, children can strangle on loose harness straps.

 **WARNING – DEATH or
SERIOUS INJURY can occur (continued)**

- Do not use this car seat after nine (9) years from the date of manufacture. The date of manufacture can be found on the label affixed to the back of this car seat.
- Do not use accessories or parts with this car seat other than those provided by Clek Inc. Use of accessories or parts from other manufacturers could alter the performance of this car seat.
- Do not attempt to make repairs to or otherwise modify or tamper with this car seat.
- Never use this car seat if it is damaged or is missing parts.
- Keep this manual in the storage compartment located on the back of this car seat for future use.
- Never use a second-hand car seat or a car seat whose history you do not know.
- Register your child restraint with Clek Inc.
- Avoid burn injury — always touch the surfaces that will contact your child first before putting them in this car seat. This car seat can become very hot if left in the sun and can burn your child's skin.

Certification

- This child restraint system conforms to all applicable Federal Motor Vehicle Safety Standards.
- This restraint is certified for use in Motor Vehicles and Aircraft.

Size & Age Limitations

 **WARNING**

- Use only in a Rear-Facing position when using this car seat with an infant less than one year old and weighing less than 20 lb (9 kg).
- Failure to choose the correct car seat mode (Rear-Facing or Forward-Facing) and to properly secure this seat and your child can increase the risk of injury or death.
- Never use this seat with children not able to sit upright alone. Their head may fall forward, which could restrict their ability to breathe.

American Academy of Pediatrics (AAP) Recommendation

The AAP advises parents to keep their toddlers in Rear-Facing car seats until age 2, or until they reach the maximum height and weight for their seat.



When Using This Car Seat in Rear-Facing Mode

- All infants less than one year old or 20 lb (9 kg) **MUST** be Rear-Facing.
- Child's weight is between 14 and 50 lb (6.4 and 22.7 kg), **AND**
- Child's height is between 25 and 43 in. (64 and 110 cm), **AND**
- Child is able to sit upright alone, **AND**
- Discontinue LATCH use when child's weight exceeds 25 lb (11.4 kg).

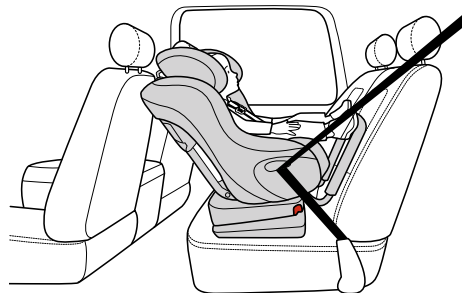

- The top of the child's head must be at least 1" (2.5 cm) below the top of the car seat's Headrest, as shown in **Figure 1**. If the top of the child's head is less than 1" (2.5 cm) below the top of the Headrest in the highest adjustment position, your child is too large for using this car seat Rear-Facing and must be transitioned to Forward-Facing use with this car seat.

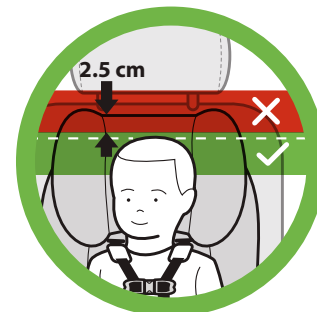

Figure 1

- The Shoulder Harness Straps must be through Shoulder Harness Slots at or below and closest to the child's shoulders, as shown in **Figure 2**.



Figure 2



When Using This Car Seat in Forward-Facing Mode

- Child's weight is between 20 and 65 lb (9.1 and 29.5 kg), AND
- Child's height is between 30 and 49 in. (76 and 124 cm), AND
- Child is at least 1 year of age, AND
- The tops of the child's ears **MUST** be below the top of the car seat's Headrest, as shown in **Figure 3**. If the tops of the child's ears are above the top of this car seat's Headrest in the highest adjustment position, your child is too large for this car seat.
- The Shoulder Harness Straps must be through Shoulder Harness Slots at or above and closest to the child's shoulders, as shown in **Figure 3a**. If the child's shoulders are above the highest set of Shoulder Harness Slots in the car seat's seat back, your child is too large for this car seat.

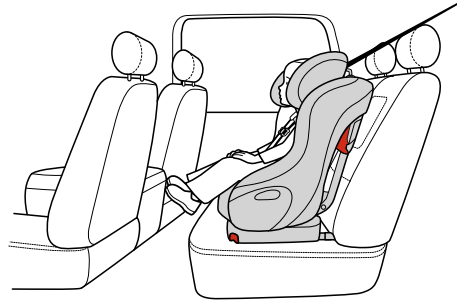

Figure 3



Figure 3a

- If child weighs more than 35 lb (15.9 kg), this car seat must be installed with:
 - the LATCH lower connectors, a Vehicle Belt and the Top Tether; or
 - a Vehicle Belt and the Top Tether

Vehicle Information



Vehicle Child Restraint Anchorage System (LATCH)

- LATCH stands for Lower Anchors and Tethers for Children. This term refers to the anchors built into a vehicle for attaching child restraints and consists of two lower anchors at the crease between the vehicle seat back and vehicle seat cushion and a top tether anchor behind the vehicle seat as shown in **Figure 4**.
- 2003 or newer model year vehicles have at least two seating locations with a LATCH Anchorage System. Some 2001 and 2002 model year vehicles have LATCH Anchorage Systems. 2000 model year vehicles or older DO NOT have LATCH Anchorage Systems. See your vehicle owner's manual if you are unsure if your vehicle is equipped with a LATCH Anchorage System.
- See your vehicle owner's manual for seating positions which can be used with LATCH.
- If not readily visible, the LATCH lower anchors may be noted by a symbol located near the crease between the vehicle seat back and vehicle seat cushion, as shown in **Figure 5**.
- If covered, the LATCH top tether anchor locations may be identified by a symbol as shown in **Figure 6**.

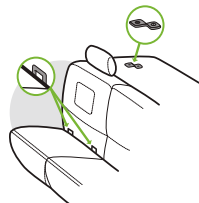

Figure 4

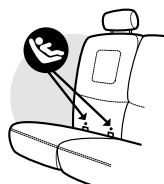

Figure 5



Figure 6

Vehicle Seat Location Requirements

WARNING

- According to accident statistics, children 12 and under are safer when properly restrained in rear vehicle seating positions, rather than front seating positions.



Figure 7

- Before using this car seat, reference your vehicle owner's manual for:
 - Car seat installation instructions
 - Information about air bags and car seat use
 - Restrictions on combined use of LATCH and Vehicle Belt
- For a toddler over one year old and Forward-Facing, if a vehicle front seat location with an air bag must be used, follow the vehicle manufacturer's instructions for child restraint use and move the vehicle seat back as far as possible.

⚠ WARNING – DEATH or SERIOUS INJURY can occur

- Do not use this child restraint Rear-Facing in a front vehicle seat location with an air bag. Child's head and neck may be seriously injured when an inflating air bag hits back of child restraint.
- Never use this car seat in a front vehicle seat location unless recommended by your vehicle owner's manual.
- Improper placement of this car seat in your vehicle increases the risk of serious injury or death. Some seating positions in your vehicle may not be safe for this car seat. Some vehicles do not have any seating positions that can be used safely with this car seat. If you are not sure where to place this car seat in your vehicle, consult your vehicle owner's manual or call 1-866-656-2462.

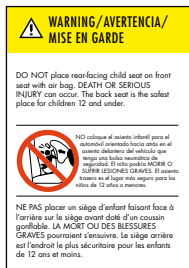

Figure 8



Figure 9

- Install this car seat only on vehicle seats that face forward. NEVER install this car seat on vehicle seats facing sideways or backwards, as shown in **Figure 9**.
- Only use this car seat on vehicle seats with seat backs that lock in an upright position. Check that the vehicle seat back is locked in an upright position recommended by the vehicle owner's manual for use when installing a child restraint.

Vehicle Belt Requirements

Refer to the vehicle owner's manual for information regarding car seat installation and vehicle belt use with a car seat.

⚠ WARNING

- Never use this car seat with a vehicle belt that is cut, damaged, frayed or inoperable.
- Using this car seat with a vehicle belt system unsafe for use with this car seat can result in serious injury or death. Pay careful attention to these systems; some of the seat belts that are not safe to use look very much like seat belts that are safe to use. If you are unsure, consult your vehicle owner's manual or call 1-866-656-2462.
- Not all vehicle belts can be used with a car seat. This car seat must be held tight at all times by the lap belt or lap portion of the lap/shoulder belt.
- Never use an inflatable vehicle belt to secure this car seat.
 - If installing this car seat using LATCH in a seating position equipped with an inflatable vehicle belt, do not buckle the vehicle belt behind this car seat.

Vehicle Belt Systems

- NEVER use a passive restraint — lap or shoulder belt mounted on door, as shown in **Figure 10**.

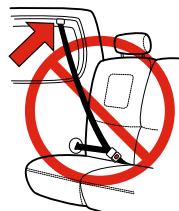

Figure 10

- NEVER use a passive restraint — lap belt with a motorized shoulder belt, as shown in **Figure 11**.



Figure 11

- NEVER use an inflatable vehicle belt.
 - Check the belt for labels and refer to your vehicle owner's manual.

- Buckle/Lap Belt Anchor Forward of Seat Bight – lap belt or lap belt portion of a lap/shoulder belt or buckle comes out of vehicle seat bottom forward of the seat back, as shown in **Figure 12**.

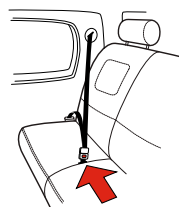

Figure 12

- May not allow for secure installation of this car seat in some cases. Check for movement of car seat after installation. If car seat is not secure, DO NOT use this vehicle belt.

- Retractable Lap Belts – Lap belt is mounted on a retractor which automatically pulls the lap belt back in when released, as shown in **Figure 13**.

- If this type of lap belt is equipped with an Emergency Locking Retractor (ELR) it should NEVER be used with this car seat.

- If this type of lap belt is equipped with an Automatic Locking Retractor (ALR), or a Switchable Locking Retractor (SLR), it can be used. See your vehicle owner's manual for more information on SLR retractor belts. To check if your retractable lap belt is equipped with an ALR retractor:

1. Pull the belt all the way out until it stops.
2. Allow the belt to pull back in about 6 in. (15 cm).
3. Pull out on belt again. If the belt will not pull out again, it is equipped with an ALR retractor.

- Manually Adjustable Lap Belts, see **Figure 14** – Length can be manually adjusted. Does not retract into the vehicle.

- Most manually adjustable lap belts will allow for secure installation, but if the locking latch plate slides, not providing a secure installation, it may be necessary to flip the locking latch plate over to get a secure installation as shown in **Figure 14a**.

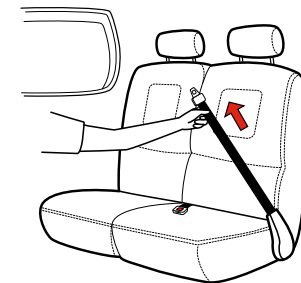

Figure 13

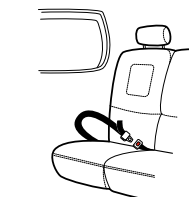

Figure 14

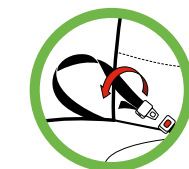

Figure 14a

- Lap/Shoulder belts with a sliding latchplate – Shoulder belt is mounted on a retractor which automatically pulls the shoulder belt back in when released as shown in **Figure 15**. Latchplate slides freely along the webbing of the vehicle belt as shown in **Figure 15a**.



Figure 15



Figure 15a

- If this type of lap/shoulder belt is equipped with an Emergency Locking Retractor (ELR), it may be used.
- If this type of lap/shoulder belt is equipped with an ELR/ALR Switchable Locking Retractor (SLR), it can be used. To check if your lap/shoulder belt is equipped with an SLR:
 1. Slowly pull the shoulder belt all the way out until it stops.
 2. Allow the shoulder belt to pull back in about 15 cm (6”).
 3. Pull out on shoulder belt again. If the belt will not pull out again, it is equipped with a SLR

NOTE: Some vehicle seat belt systems may have a lap/shoulder belt equipped with a latchplate which appears to hold the lap portion at a fixed length when the belt is pulled tight. This type of lap/shoulder belt is compatible. It may still have a switchable locking retractor (SLR).

See your vehicle owner’s manual for more information on installing a child seat using the vehicle belt.

Before Installing Car Seat

This Car Seat is shipped without the Headrest attached. The Headrest must be installed on the seat prior to use, see “Installing/Adjusting Headrest” on page 86.



Rear-Facing

The following are a few things which must be done with this car seat before installing it in a vehicle Rear-Facing.

- Rear-Facing Base must be securely attached to the bottom of the car seat. See “Installing/Removing Rear-Facing Base” on page 80.
- Shoulder Harness must be adjusted to the correct Shoulder Harness Slots for the height of the child. The Shoulder Harness should be through the Shoulder Harness Slots closest to and at or below your child’s shoulders. See “Securing your Child in Car Seat” on page 65.
- Select recline position 3 (fully reclined).
 - Rear-Facing Anti-Rebound Bar must be securely attached to the car seat with the Locking Pins. See “Installing/Removing Rear-Facing Anti-Rebound Bar” on page 81



Forward-Facing

The following are a few things which must be done with this car seat before installing it in a vehicle Forward-Facing.

- Rear-Facing Base and Anti-Rebound Bar must NOT be attached to the car seat. See “Installing/Removing Rear-Facing Base” on page 80, and “Installing/Removing Rear-Facing Anti-Rebound Bar” on page 81.
- Shoulder Harness must be adjusted to the correct Shoulder Harness Slots for the height of the child. The Shoulder Harness should be through the Shoulder Harness Slots closest to and at or above your child’s shoulders. See “Securing your Child in Car Seat” on page 65.



Installing/Removing Rear-Facing Car Seat

 **WARNING – DEATH or SERIOUS INJURY can occur**

- Never use this car seat Rear-Facing in a vehicle front seating location with an air bag.
- LATCH or vehicle belt must be routed through Rear-Facing Belt Path when using car seat Rear-Facing.

 **WARNING – DEATH or SERIOUS INJURY can occur (continued)**

- The Rear-Facing Base and Anti-Rebound Bar must be used when using seat Rear-Facing.
- LATCH or vehicle belt must stay tightly adjusted around car seat at all times.
- Failure to properly install or use this car seat increases the risk of serious injury or death to the child and others in a sharp turn, sudden stop or crash.
- Seat must be properly reclined, within an acceptable recline range for the child’s age when used Rear-Facing. If the seat is reclined too much, infants can be ejected from the car seat in an accident. If too upright, it can cause breathing problems.
- To avoid injury this car seat must be installed by an adult.
- Never leave this car seat unsecured in your vehicle. This car seat must remain secured even when not in use. In a sharp turn, crash or sudden stop, an unsecured car seat can be thrown around and could severely injure vehicle occupants.



Installing Rear-Facing Car Seat with LATCH

! WARNING – DEATH or SERIOUS INJURY can occur

- Only use the car seat LATCH system in vehicle seating locations designated by the vehicle manufacturer for use with LATCH and that have an anchor spacing of 11 in. (280 mm).
- Rear-Facing LATCH Push-on Connectors must be secured to the vehicle LATCH lower anchors only. Connection to other vehicle anchors or vehicle components could result in the anchor tearing free in a crash.
- Never attach more than one push-on connector to a vehicle lower anchor unless recommended by the vehicle owner's manual for that vehicle.
- Rear-Facing LATCH belt must be routed through Rear-Facing Belt Path.
- Do NOT install by this method for a child weighing more than 25 lb (11.4 kg).

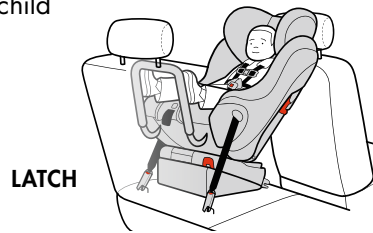

Step 1

If Rear-Facing Base is not securely attached to the seat, install it now, see "Installing/Removing Rear-Facing Base" on page 80.

- Anti-Rebound Bar must also be securely attached to the car seat with the Locking Pins, see "Installing/Removing Rear-Facing Anti-Rebound Bar" on page 81.

Step 2

Select a Forward-Facing vehicle seating location which has LATCH.

Locate the LATCH lower anchors (as explained in the "Vehicle Child Restraint Anchorage System (LATCH)" on page 17 in this manual and in your vehicle owner's manual. See **Figure 16**.

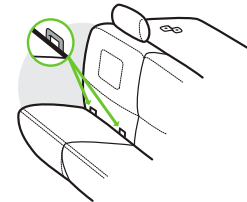

Figure 16

Step 3

If the vehicle seat back is adjustable, make sure the seat back is locked in a more upright position. Refer to vehicle owner's manual for recommended seat back angle. DO NOT install or use this car seat while the vehicle seat back is excessively reclined, as shown in **Figure 17**.



Figure 17

Step 4

Remove Seat Cushion, see “Removing/Installing Seat Cushion” on page 84.

Remove Rear-Facing LATCH belt from its storage location under the Seat Cushion, see “Rear-Facing LATCH Storage” on page 88.

Lengthen each side of Rear-Facing LATCH belt by pressing adjuster release button while pulling belt to extend the length of lower anchor belt as shown in **Figure 18**.

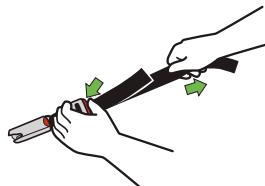

Figure 18

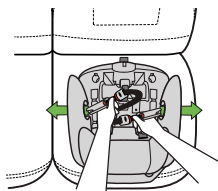

Figure 19

Step 5

Route the Rear-Facing LATCH Belt through the Rear-Facing Belt Path, as shown in **Figure 19**.

Step 6

Center the Rear-Facing LATCH Belt in the Belt Path and place it under the two forward Belt Tabs and over Rear-Facing Belt Lock-offs as shown in **Figure 20**.

Check that Crotch Strap is not under Rear-Facing LATCH Belt as shown in **Figure 20a**.

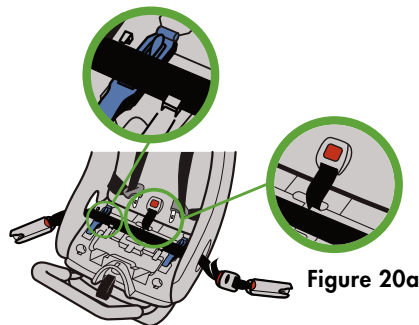

Figure 20

Figure 20a

Step 7

Place car seat Rear-Facing in the vehicle seat location selected with Rear-Facing Belt Path toward vehicle seat back and centered between the vehicle lower anchors as shown in **Figure 21**.

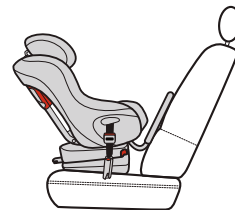

Figure 21

Step 8

Secure Rear-Facing LATCH Push-on Connectors to the vehicle LATCH lower anchors. For each connector:

- Position red release button of Rear-Facing LATCH Push-On Connector facing away from car seat.
- Align LATCH Connector with the vehicle LATCH anchor and press the LATCH Connector against the LATCH anchor until you hear the LATCH Connector click, as shown in **Figure 22**.
- Pull on LATCH Connector to check that it is securely locked on the vehicle LATCH anchor.



Figure 22

Step 9

Tighten Rear-Facing LATCH Belt to secure the car seat.

- Press down in center of car seat to depress the vehicle seat cushion and pull free end of Rear-Facing LATCH Belt to tighten as shown in **Figure 23**.
- Repeat for opposite side of Rear-Facing LATCH Belt.

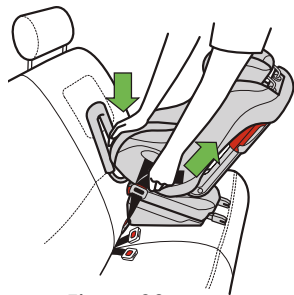

Figure 23

Step 10

Check for secure installation. Gripping car seat at top of armrests, pull car seat front to back and left to right to check for secure installation as shown in **Figure 24**. LATCH belt **MUST** stay tight and child restraint should not move more than 1" (2.5 cm) in any direction.

- If LATCH belt does not stay tight or car seat cannot be securely installed, try a different LATCH location or install using the vehicle belt, see "Installing/Removing Rear-Facing Car Seat With Vehicle Belt" on page 35.

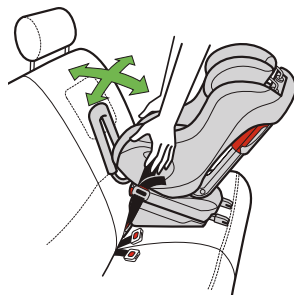

Figure 24

Step 11

Ground Level must be within the recline range designated for the age of the child. If an acceptable recline level cannot be achieved using the vehicle seat back adjustment, if vehicle owner's manual allows multiple positions, it may be necessary to place a rolled towel or pool noodle under the foot end of the car seat to achieve an acceptable recline level.

Verify Ground Level is within the recline range designated for the age of the child as shown in **Figure 25**. If not, go back to **Step 7** adjust the recline level and try installing again, or move the seat to a different vehicle seating position.

IMPORTANT: If the seat is reclined too much, the child could be ejected from the car seat in a crash. If too upright, infants could have difficulty breathing.

Step 12

Install Seat Cushion, see "Removing/Installing Seat Cushion" on page 84.



Figure 25



Removing Rear-Facing Car Seat Installed With LATCH

Step 1

Loosen Rear-Facing LATCH Belt by pressing the adjuster button on each Rear-Facing LATCH Belt adjuster and pulling out on Rear-Facing LATCH Belt as shown in **Figure 26**.

- Pressing down in center of car seat to reduce tension on Rear-Facing LATCH Belt will make it easier to loosen lower anchor belt.

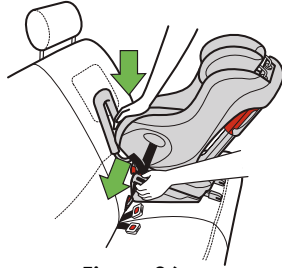

Figure 26

Step 2

Remove Rear-Facing LATCH Push-on Connectors from vehicle lower anchors.

- Press and hold red release button while pulling Rear-Facing LATCH push-on Connectors as shown in **Figure 27**.
- Repeat to remove Push-on Connector on opposite side.

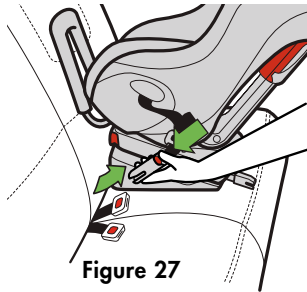

Figure 27

Step 3

Remove this car seat from vehicle.

Step 4

Remove Seat Cushion, See "Removing/Installing Seat Cushion" on page 84.

Store the Rear-Facing LATCH Belt, see "Rear-Facing LATCH Storage" on page 88.

Step 5

Install Seat Cushion, See "Removing/Installing Seat Cushion" on page 84.



Installing Rear-Facing Car Seat With Vehicle Belt



WARNING – DEATH or SERIOUS INJURY can occur

- Not all vehicle belts are safe for use with this car seat. Read the vehicle belt requirements section in this manual and your vehicle owner's manual.
- Vehicle belt must be routed through Rear-Facing Belt Path when car seat is installed Rear-Facing.

Step 1

If Rear-Facing Base is not securely attached to the seat, install it now, see "Installing/Removing Rear-Facing Base" on page 80.

- Anti-Rebound Bar must be securely attached to the car seat with the Locking Pins, see "Installing/Removing Rear-Facing Anti-Rebound Bar" on page 81.

Step 2

Select a Forward-Facing vehicle seating location which has a vehicle belt which can be used with this car seat.

Step 3

If the vehicle seat back is adjustable, make sure the seat back is locked in a more upright position. Refer to vehicle owner's manual for recommended seat back angle. **DO NOT** install or use this car seat while the vehicle seat back is excessively reclined, as shown in **Figure 28**.



Figure 28

Step 4

Remove Seat Cushion, see "Removing/Installing Seat Cushion" on page 84.

Step 5

Place car seat Rear-Facing in the vehicle seat location selected with Rear-Facing Belt Path toward vehicle seat back and centered in seating position as shown in **Figure 29**.

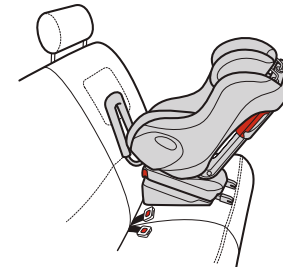

Figure 29

Step 6

If installing with a lap/shoulder belt, open one (1) Rear-Facing Belt Lock-off as shown in **Figure 30**. You may use whichever Lock-off provides the most secure installation.

NOTE: If your vehicle's belt system is equipped with an ELR/ALR Switchable Locking Retractor (SLR), or if you are installing with a lap belt, you may skip **Step 6**, and install your car seat **WITHOUT** using a Rear-Facing Belt Lock-off. Refer to the Child Restraint section of your vehicle manual to understand what type of belt system your vehicle is equipped with.

Step 7

Route vehicle belt through the Rear-Facing Belt Path and under the four Belt Tabs, as shown in **Figure 31a**, and buckle vehicle belt, as shown in **Figure 31**.

Check that Crotch Strap is not under the vehicle belt as shown in **Figure 31b**.

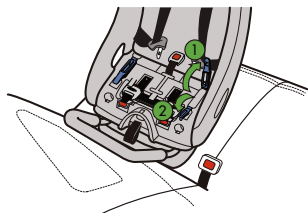

Figure 30

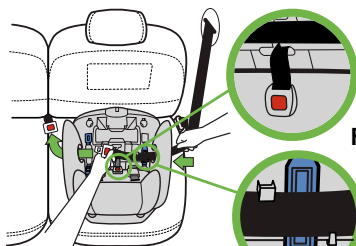

Figure 31



Figure 31b

Figure 31a

Step 8

Choose the option that matches the type of installation you are doing:

Option 1 – If installing with lap/shoulder belt using a Rear-Facing Lock-off:

Tighten vehicle belt to secure the car seat.

- Press down in center of car seat to depress the vehicle cushion and pull free the shoulder portion of lap/shoulder belt to tighten as shown in **Figure 32**.
- While holding the vehicle belt tight, close Rear-Facing Belt Lock-off as shown in **Figure 33**.

IMPORTANT: If Lock-off will not close easily, it may be necessary to loosen the belt slightly in order to properly position the belt under the Belt Tabs and close the Lock-off.

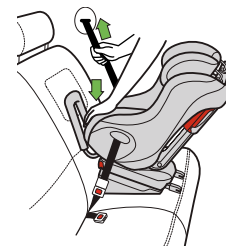

Figure 32

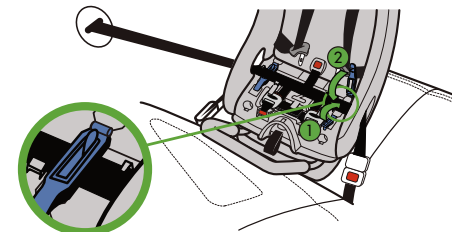

Figure 33

Check that the entire lap/shoulder belt (both the lap and shoulder portions of the belt) is under all four Belt Tabs as shown in **Figure 34**.

NOTE: If your vehicle's belt system is equipped with an ELR/ALR Switchable Retractor (SLR), it is also recommended to engage the ALR by slowly pulling the vehicle belt all the way out until it stops. Then, feed the belt back into the retractor.

Option 2 — If installing with lap/shoulder belt WITHOUT using a Rear-Facing Lock-off:

Tighten vehicle belt to secure the car seat

- Engage the vehicle's ALR by slowly pulling the vehicle belt all the way out until it stops. Then, feed the belt back into the retractor.
- Press down in center of car seat to depress the vehicle cushion and pull free the shoulder portion of lap/shoulder belt to tighten as shown in **Figure 32**, feeding any remaining belt webbing back into the retractor.

Check that the entire lap/shoulder belt is under all four Belt Tabs and over both Rear-Facing Lock-offs as shown in **Figure 35**.

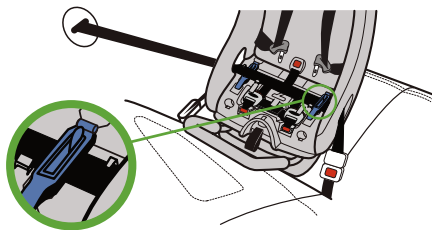

Figure 34

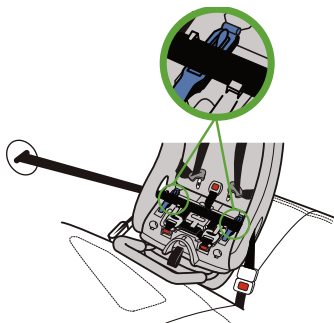

Figure 35

Option 3 — If installing with lap-only belt:

Tighten vehicle belt to secure the car seat

- Press down in center of car seat to depress the vehicle cushion and pull free the end of the lap belt to tighten as shown in **Figure 36**.

Check that the entire lap belt is under all four Belt Tabs and over both Rear-Facing Lock-offs as shown in **Figure 37**.

Step 9

Check for secure installation. Gripping car seat at top of armrests, pull car seat front to back and left to right to check for secure installation as shown in **Figure 38**. Vehicle belt **MUST** stay tight and child restraint should not move more than 1" (2.5 cm) in any direction.

- If vehicle belt does not stay tight, try installing the car seat using Rear-Facing Belt Lock-off. Go back to **Step 6**.
- If vehicle belt still does not stay tight or car seat cannot be securely installed, try a different vehicle seat location or install using LATCH, see "Installing/Removing Car Seat Rear-Facing With LATCH" on page 27.

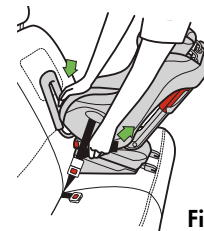

Figure 36

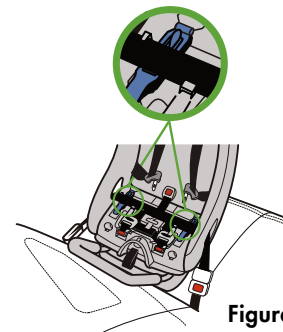

Figure 37

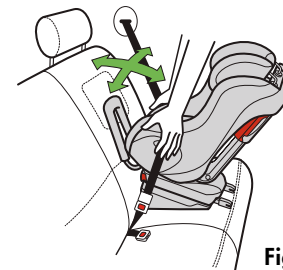

Figure 38

Step 10

Ground Level must be within the recline range designated for the age of the child. If an acceptable recline level cannot be achieved using the vehicle seat back adjustment, if vehicle owner's manual allows multiple positions, it may be necessary to place a rolled towel or pool noodle under the foot end of the car seat to achieve an acceptable recline level.

Verify Ground Level is within the recline range designated for the age of the child as shown in **Figure 39**. If not, go back to **Step 5**, adjust the recline level and try installing again, or move the seat to a different vehicle seating position.

- **IMPORTANT:** If the seat is reclined too much, the child could be ejected from the car seat in a crash. If too upright, infants could have difficulty breathing.

Step 11

Install Seat Cushion, see "Removing/Installing Seat Cushion" on page 84.

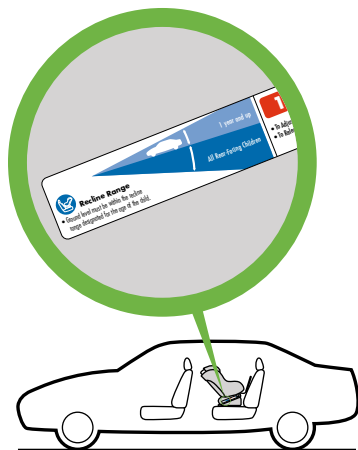

Figure 39



Removing Rear-Facing Car Seat Installed With Vehicle Belt

Step 1

Unbuckle vehicle belt.

- Pressing down in center of car seat to reduce tension on vehicle belt will make it easier to unbuckle vehicle belt as shown in **Figure 40**.

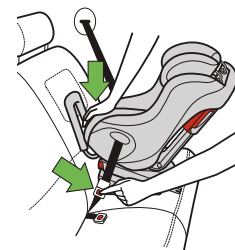

Figure 40

Step 2

Remove Seat Cushion, see "Removing/Installing Seat Cushion" on page 84.

Step 3

If used, open Rear-Facing Belt Lock-off as shown in **Figure 41**.

Remove vehicle belt from Rear-Facing Belt Path.

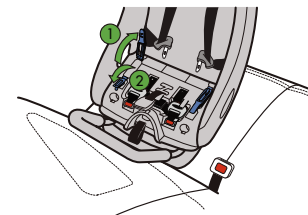

Figure 41

Step 4

Remove this car seat from vehicle.

Step 5

Install Seat Cushion, See "Removing/Installing Seat Cushion" on page 84.



Installing/Removing Forward-Facing Car Seat

WARNING – DEATH or SERIOUS INJURY can occur

- All children less than one year old and 20 lb (9.1 kg) must use this car seat Rear-Facing. Serious injury or death can result if infant faces front of vehicle.
- Rear-Facing Base and Anti-Rebound Bar must be removed when using seat Forward-Facing.
- LATCH or vehicle belt must stay tightly adjusted at all times.
- Seat must be in a Forward-Facing recline position when used Forward-Facing.
- To avoid injury, this car seat must be installed by an adult.
- Do not install this car seat Forward-Facing with the Rear-Facing LATCH Belt. Only Rigid LATCH should be used to install this car seat Forward-Facing with the vehicle's LATCH anchorage system.
- Failure to properly install or use this car seat increases the risk of serious injury or death to the child and others in a sharp turn, sudden stop or crash.



Installing Forward-Facing Car Seat With LATCH

WARNING – DEATH or SERIOUS INJURY can occur

- Never leave this car seat unsecured in your vehicle. This car seat must remain secured even when not in use. In a sharp turn, crash or sudden stop, an unsecured car seat can be thrown around and could severely injure vehicle occupants.
- Only use this car seat LATCH system in vehicle seating locations designated by the vehicle manufacturer for use with LATCH and that have an anchor spacing of 11 in. (280 mm).
- LATCH Connectors must be secured to the vehicle LATCH lower anchors only. Connection to other vehicle anchors or vehicle components could result in the anchor tearing free in a crash.
- Never attach more than one LATCH connector to a vehicle lower anchor unless recommended by the vehicle owner's manual for that vehicle.
- ALWAYS secure the Top Tether provided with this car seat when installing Forward-Facing with Rigid LATCH. NEVER use this car seat, when installing Forward-Facing with Rigid LATCH, without the Top Tether.
- NEVER use recline position 1 Forward-Facing without a Top Tether.

⚠ WARNING – DEATH or SERIOUS INJURY can occur (continued)

- Do NOT install by this method for a child weighing more than 35 lb (15.9 kg).
- For children over 35 lb (15.9 kg), LATCH and Vehicle Belt can be used in combination up to 65 lb (29.5 kg) in Forward-Facing Mode only.
- NEVER use this car seat, when installed with Rigid LATCH, while the Yellow and Black Rigid LATCH Label is visible, as shown in **Figure 42**, unless the Top Tether is attached as instructed in this manual.

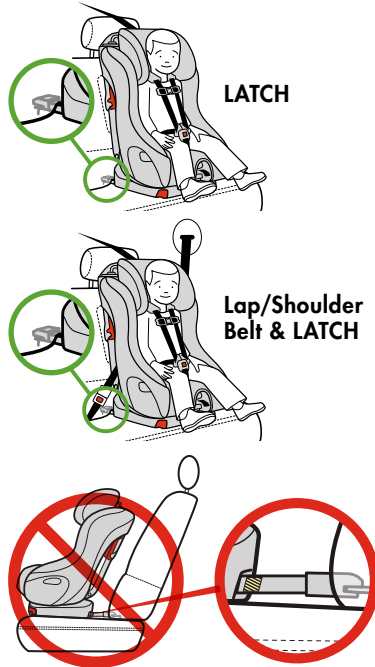

Figure 42

Step 1

If Rear-Facing Base or Anti-Rebound Bar is attached, remove it now, see “Installing/Removing Rear-Facing Base” on page 80 and “Installing/Removing Rear-Facing Anti-Rebound Bar” on page 81.

Step 2

Select a Forward-Facing vehicle seating location which has LATCH.

Locate the LATCH lower and top anchors (as explained in the “Vehicle Child Restraint Anchorage System (LATCH)” on page 17 in this manual and in your vehicle owner’s manual). See **Figure 43**.

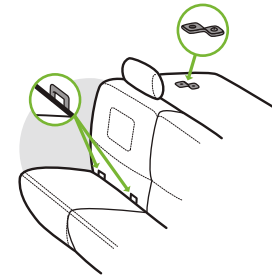

Figure 43

Step 3

If the vehicle seat back is adjustable, make sure the seat back is locked in a more upright position. Refer to vehicle owner’s manual for recommended seat back angle. DO NOT install or use this car seat while the vehicle seat back is excessively reclined, as shown in **Figure 44**.



Figure 44

Step 4

Adjust car seat to the desired Forward-Facing recline position by pulling Recline Handle out and rotating car seat as shown in **Figure 45**.

NOTE: Recline positions 1 and 2 can be used Forward-Facing. Recline position 1 CANNOT be used Forward-Facing without a Top Tether. Recline Position 3 can NEVER be used Forward-Facing.

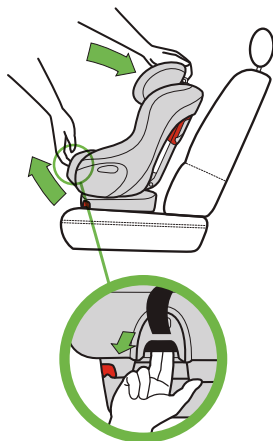

Figure 45

Step 5

Pull Rigid LATCH Lower Connectors to the fully extended position as shown in **Figure 46**.

- Pull and hold Rigid LATCH Adjustment Handle.
- Grasp the back of the Rigid LATCH Lower Connectors and pull out until they stop.
- Release Rigid LATCH Adjustment Handle.

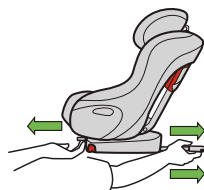

Figure 46

Step 6

Remove Top Tether Hook from its storage location on back of car seat. See "Top Tether Storage" on page 90.

- Lengthen Top Tether belt by pressing adjuster release button while pulling strap as shown in **Figure 47**.
- Place Top Tether Hook in the seat of the car seat.

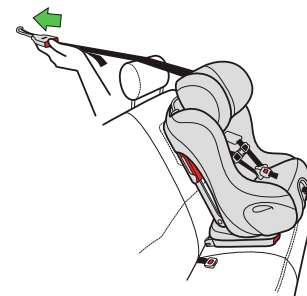

Figure 47

Step 7

This car seat may be installed forward-facing with both LATCH AND the vehicle belt. This type of installation will allow the LATCH lower anchors to be used until the child reaches the maximum size requirements of the seat.

IMPORTANT: NEVER install this car seat using both LATCH and the vehicle belt if prohibited in the vehicle's owner's manual or if either of the conditions shown in **Figures 48** and **49** exist.

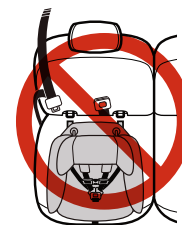

Figure 48

Seat belt buckle is located in between LATCH anchors

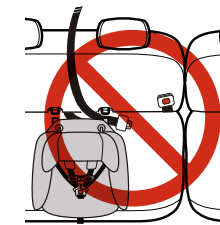

Figure 49

Seat belt is located in between LATCH anchors

If installing with LATCH lower anchors, the vehicle belt and Top Tether:

Route vehicle belt through the Forward-Facing Belt Path, taking care not to put vehicle belt between Harness and back of seat, and buckle seat belt, as shown in **Figure 50**.

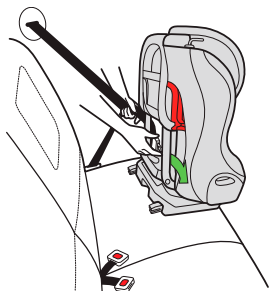

Figure 50

Open the Forward-Facing Belt Lock-off on the same side of the seat as the vehicle shoulder belt anchor point as shown in **Figure 51**. Place the vehicle shoulder belt through the Forward-Facing Belt Lock-off as shown in **Figure 51a**.

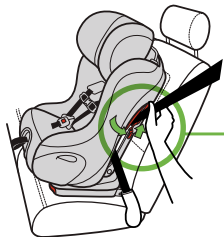

Figure 51



Figure 51a

Step 8

Place car seat in the seating location selected with the Rigid LATCH Lower Connectors facing the vehicle seat.

Secure the Rigid LATCH Lower Connectors to the vehicle LATCH lower anchors by aligning the LATCH Connectors with the vehicle LATCH lower anchors and pressing the LATCH Connectors against the LATCH lower anchors until each LATCH Connector locks, as shown in **Figure 52** and **52a**.

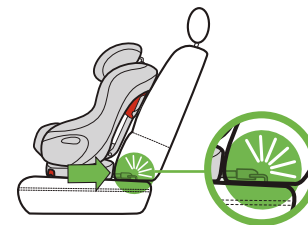

Figure 52

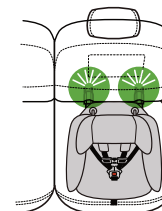

Figure 52a

Step 9

Once the LATCH Connectors are connected to the LATCH lower anchors, check both LATCH connector lock indicators located behind the LATCH connectors to make sure they have changed from red (unlocked) to green (locked) as shown in **Figure 53**. Pull forward on this car seat to make sure it is securely attached to the vehicle's LATCH lower anchors on both sides. If not, go back to **Step 8**. If LATCH cannot be successfully connected in this seating position, it may be necessary to try a different seating position, go back to **Step 2**.

IMPORTANT: If LATCH Connectors fail to connect to the vehicle's LATCH lower anchors, you can still use this seat. See "Installing/Removing Car Seat Forward-Facing: Using Vehicle Belt" on page 57. Please notify Clek Customer Service if the LATCH Connectors fail to latch by calling 1-866-656-2462.

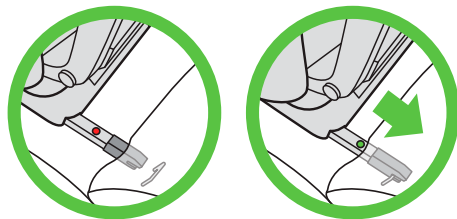

Figure 53

Step 10

Adjust seat to fit snugly against the vehicle seat back as shown in **Figure 54**.

- Pull and hold Rigid LATCH Adjustment Handle.
- Push car seat firmly into vehicle seat back.
- Release Rigid LATCH Adjustment Handle.

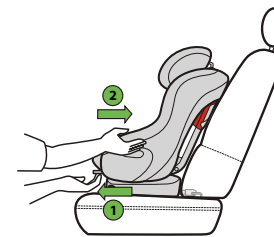

Figure 54

If installing with LATCH and the vehicle belt:

- Pull free end lap belt only or shoulder portion of lap/shoulder belt to remove excess slack as shown in **Figure 55** (lap belt only) or **Figure 55a** (lap/shoulder belt)
- If using a lap/shoulder belt: while holding the vehicle belt tight, lock Forward-Facing Belt Lock-off as shown in **Figure 56**.

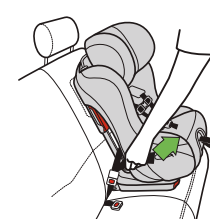

Figure 55

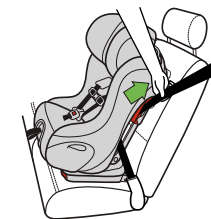

Figure 55a

NOTE: Use only one Shoulder Belt Lock-Off at a time. Never use both in the Forward-Facing Mode.

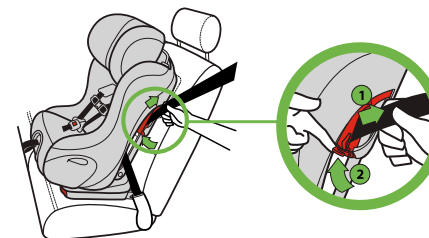

Figure 56

Step 11

Check fit against the vehicle seat back. If the back of this car seat cannot be adjusted to be in contact with the vehicle seat back as shown in **Figure 57**, try changing the recline position of this car seat, verify that the vehicle seat back is in a more upright position and re-adjust. If this seat cannot be positioned so that car seat back is in contact with the vehicle seat back, try a different LATCH equipped vehicle seating position, or install with a vehicle belt, see "Installing/Removing Car Seat Forward-Facing: Using Vehicle Belt" on page 57.

A small gap between the top or bottom of the car seat and vehicle seat back is acceptable as long as there is contact with the front surface of the vehicle seat back or headrest.

Figure 58 shows an unacceptable gap.



Figure 57



Figure 58

Step 12

Attach Tether Hook to vehicle top tether anchor as shown in **Figure 59** or **Figure 59a** and pull firmly on free end of strap until Top Tether is snug.

Refer to vehicle owner's manual for recommended Top Tether routing and identification of top tether anchor point.

IMPORTANT: NEVER use the car seat without a Top Tether.

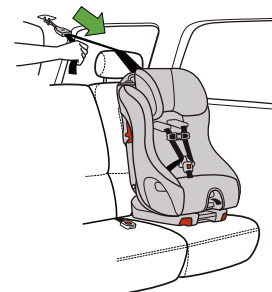

Figure 59

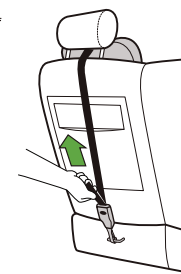

Figure 59a

Step 13

Check for secure installation. Gripping car seat at top of armrests, pull car seat front to back and left to right to check for secure installation as shown in **Figure 60**. LATCH system must stay tight and child restraint should not move more than 1" (2.5 cm) in any direction.

- If LATCH system does not stay tight or car seat cannot be securely installed, try a different LATCH location or install using the vehicle belt, see "Installing/Removing Car Seat Forward-Facing Using Vehicle Belt" on page 51.



Figure 60



Removing Forward-Facing Car Seat Installed With LATCH

Step 1

Loosen Top Tether by pressing adjuster release button while pulling strap as shown in **Figure 61**.

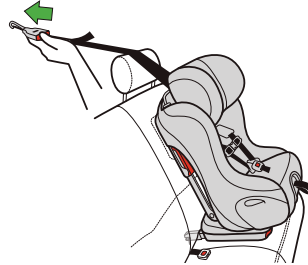

Figure 61

Step 2

Remove Tether Hook from vehicle tether anchor.

- Pull in and hold retention spring on hook, then remove hook from Tether Anchor as shown in **Figure 62** or **Figure 62a**.

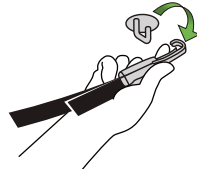

Figure 62



Figure 62a

Step 3

If using LATCH and vehicle belt, open Shoulder Belt Lock-off and unbuckle vehicle belt.

Step 4

Pull Rigid LATCH Lower Connectors to the fully extended position as shown in **Figure 63**.

- Pull and hold Rigid LATCH Adjustment Handle.
- Grasp the seat and slide it out until it stops.
- Release Rigid LATCH Adjustment Handle.

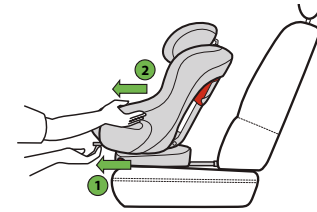

Figure 63

Step 5

Pull the red Rigid LATCH Release Handles, one at a time and pull the car seat forward to remove each Rigid LATCH Connector from the vehicle LATCH anchor as shown in **Figure 64**.

IMPORTANT: Rigid LATCH Connectors CANNOT be released unless they are FULLY extended.

NOTE: Moving the car seat slightly from front to back or side to side may make it easier to release the Rigid LATCH Connectors from the vehicle LATCH anchors.

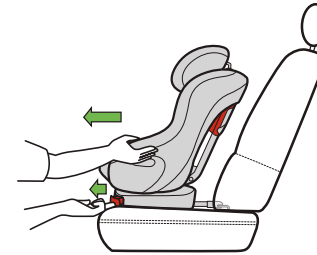

Figure 64

Step 6

Remove this car seat from vehicle.

Step 7

Store the Top Tether and Rigid LATCH Connectors, see "Top Tether Storage" and "Forward-Facing Rigid LATCH Storage" on page 90.



Installing Forward-Facing Car Seat With Vehicle Belt

⚠ WARNING – DEATH or SERIOUS INJURY can occur

- Vehicle belt must be routed through Forward-Facing Belt Path when using car seat Forward-Facing.
- Forward-Facing Belt Lock-off must be used when installing with lap/shoulder belt.
- Not all vehicle belts are safe for use with this car seat. Read the “Vehicle Belt Requirements” section in this manual and your vehicle owner’s manual.
- ALWAYS secure the Top Tether provided with this car seat when installing Forward-Facing with a lap belt. NEVER use this car seat, when installing Forward-Facing with a lap belt, without the Top Tether.
- ALWAYS secure the Top Tether provided with this car seat when installing Forward-Facing with lap/shoulder belt unless no Top Tether anchorage is available.
- NEVER use recline position 2 Forward-Facing without a Top Tether.
- NEVER use any of the 3 lowest sets of Shoulder Harness Slots when installing this seat with a lap belt.

Step 1

If Rear-Facing Base or Anti-Rebound Bar is attached, remove it now, see “Installing/Removing Rear-Facing Base” on page 80 and “Installing/Removing Rear-Facing Anti-Rebound Bar” on page 81.

Step 2

Select a Forward-Facing vehicle seating location which has a vehicle belt which can be used with this seat and a top tether anchor point.

NOTE: If no vehicle seating location with a top tether anchor point is available, this car seat can be installed with a lap/shoulder belt. NEVER install this Car Seat with a lap belt without a Top Tether.

Step 3

If the vehicle seat back is adjustable, make sure the seat back is locked in a more upright position. Refer to vehicle owner’s manual for recommended seat back angle. DO NOT install or use this car seat while the vehicle seat back is excessively reclined, as shown in **Figure 65**.



Figure 65

Step 4

Adjust car seat to the desired Forward-Facing recline position by pulling Recline Handle out and rotating car seat as shown in **Figure 66**.

NOTE: Recline positions 1 and 2 can be used Forward-Facing. Recline position 2 CANNOT be used without a Top Tether Forward-Facing. Recline Position 3 can NEVER be used Forward-Facing.

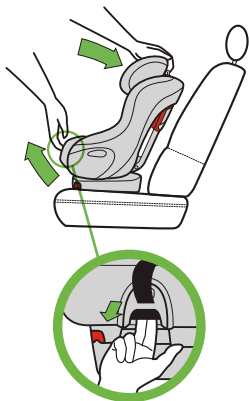

Figure 66

Step 5

Remove Tether Hook from its storage location on back of car seat. See "Top Tether Storage" on page 90.

- Lengthen Top Tether belt by pressing adjuster release button while pulling strap as shown in **Figure 67**.
- Place Top Tether Hook in the seat of the car seat.

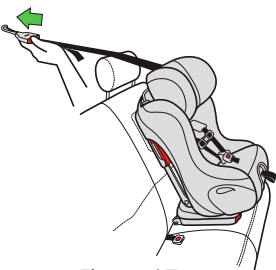

Figure 67

Step 6

Place car seat Forward-Facing in the vehicle seat location selected with Forward-Facing belt path toward vehicle seat back and centered in seating position as shown in **Figure 68**.

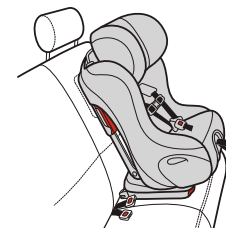

Figure 68

Step 7

Route vehicle belt through the Forward-Facing Belt Path, taking care not to put vehicle belt between Harness and back of seat, and buckle seat belt, as shown in **Figure 69**.

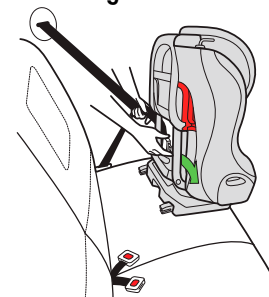

Figure 69

Step 8

If installing with a lap/shoulder belt, open the Forward-Facing Belt Lock-off on the same side of the seat as the vehicle shoulder belt anchor point as shown in **Figure 70**. Place the vehicle shoulder belt through the Forward-Facing Belt Lock-off as shown in **Figure 70a**.

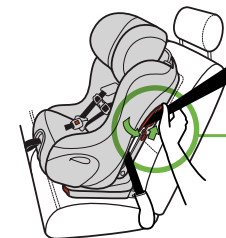

Figure 70

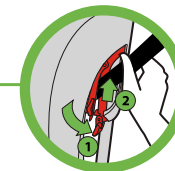

Figure 70a

Step 9

Tighten vehicle seat belt to secure the car seat.

- Press down in center of car seat to depress the vehicle cushion and pull free end lap belt only or shoulder portion of lap/shoulder belt to tighten as shown in **Figure 71** (lap belt only) or **Figure 71a** (lap/shoulder belt).

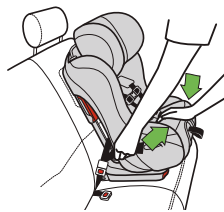

Figure 71

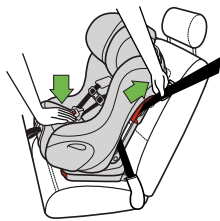

Figure 71a

- If using a lap/shoulder belt: while holding the vehicle belt tight, lock Forward-Facing Belt Lock-off as shown in **Figure 72**.

NOTE: Use only one Shoulder Belt Lock-Off at a time. Never use both in the Forward-Facing Mode.

Step 10

Check that the entire belt is laying flat, placed correctly in the Belt Path as shown in **Figure 73** (lap belt only) and **Figure 73a** (lap/shoulder belt) and NOT between the harness and seat.

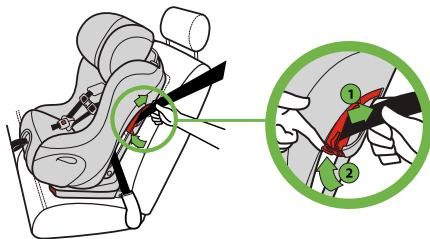

Figure 72

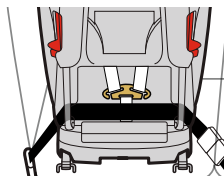

Figure 73



Figure 73a

Step 11

Attach Tether Hook to vehicle top tether anchor as shown in **Figure 74** or **Figure 74a** and pull firmly on free end of strap until Top Tether is snug.

NEVER secure this car seat when installing with a lap belt without using the Top Tether.

Refer to vehicle owner's manual for recommended Top Tether routing and identification of top tether anchor point.



Figure 74

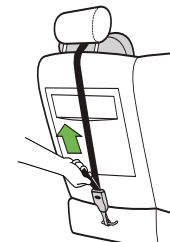

Figure 74a

Step 12

Check for secure installation. Gripping car seat at top of armrests, pull car seat front to back and left to right to check for secure installation as shown in **Figure 75**. Vehicle belts and Top Tether must stay tight and child restraint should not move more than 1" (2.5 cm) in any direction.

- If vehicle belt does not stay tight or car seat cannot be securely installed, try a different vehicle seating location or install using LATCH, see "Installing/Removing Car Seat Forward-Facing Using LATCH" on page 44.

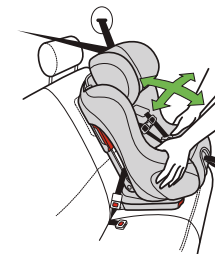

Figure 75



Removing Forward-Facing Car Seat Installed With Vehicle Belt

Step 1

Loosen Top Tether by pressing Tether Adjuster release button while pulling strap as shown in **Figure 76**.

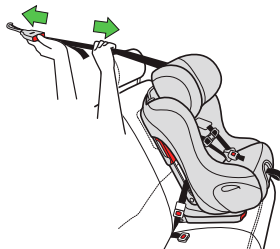

Figure 76

Step 2

Remove Tether Hook from vehicle Tether Anchor.

- Pull in and hold retention spring on hook, then remove hook from tether anchor as shown in **Figure 77** or **Figure 77a**.

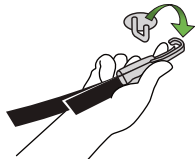

Figure 77



Figure 77a

Step 3

Unbuckle vehicle belt.

- Pressing down in center of car seat to reduce tension on vehicle belt will make it easier to unbuckle vehicle belt as shown in **Figure 78**.

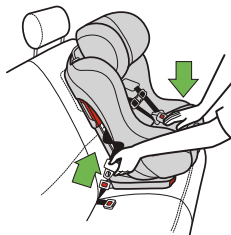

Figure 78

Step 4

Open Forward-Facing Belt Lock-off as shown in **Figure 79**.

Remove vehicle belt from Forward-Facing Belt Path.

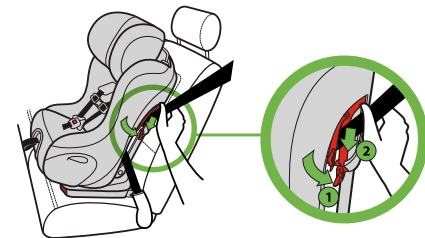

Figure 79

Step 5

Remove this car seat from vehicle.

Step 6

Store the Top Tether, see "Top Tether Storage" on page 90.

Securing Your Child in Car Seat

 **WARNING – DEATH or SERIOUS INJURY can occur**

- Check that Harness fits child snugly each time they are buckled into seat.
- To avoid injury, child must be secured by an adult. Never allow the child to buckle themselves in this car seat.
- Child must be dressed in clothing with arms and legs that will not interfere with buckling and snugly adjusting Harness.
- Never place blankets between Harness and child.
- Prevent death from heat exposure: never leave child unattended, even when sleeping. Vehicle interiors can reach very high temperatures quickly, even when it is not a hot or sunny day.
- Strangulation hazard: child can strangle in loose Harness Straps. Never leave child in car seat when Harness Straps are loose or undone.
- The bottom of the Headrest must always be at or above the Harness Slots in use.
- NEVER use any of the 3 lowest sets of Shoulder Harness Slots when installing this seat Forward-Facing with a lap belt.
- Always use the Buckle Pad supplied with this car seat for children weighing up to 22 lb (10 kg).
- Never use the longer Crotch Strap length in the rear Crotch Strap Slot.

Step 1

Check position of Shoulder Harness:

- **Rear-Facing** - The Shoulder Harness Straps must be through Shoulder Harness Slots at or below and closest to the child's shoulders, as shown in **Figure 80**.
- **Forward-Facing** - The Shoulder Harness Straps must be through Shoulder Harness Slots at or above and closest to the child's shoulders, as shown in **Figure 81**.
 - NEVER use any of the lowest 3 sets of Shoulder Harness Slots when installing this seat Forward-Facing with a lap belt.

If the child's shoulders are above the highest set of Shoulder Belt Slots in the car seat's seat back, your child is too large for this car seat.

See "Shoulder Harness Height Adjustment" on page 73 to change position of Shoulder Harness Straps.

Step 2

Check Position of Headrest:

- The bottom of the Headrest must always be at or above the Harness Slots in use.



Figure 80



Figure 81

- **Rear-Facing** - The top of the child's head must be at least 1" (2.5 cm) below the top of the car seat's Headrest, as shown in **Figure 82**. If the top of the child's head is less than 1" (2.5 cm) below the top of the Headrest in the highest adjustment position, your child is too large for using this car seat Rear-Facing and must be transitioned to Forward-Facing use with this car seat.

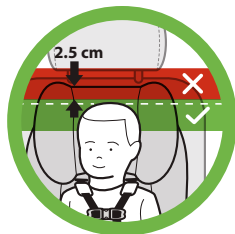

Figure 82

- **Forward-Facing** - The tops of the child's ears MUST be below the top of the car seat's Headrest, as shown in **Figure 83**. If the tops of the ears are above the top of this car seat's Headrest in the highest adjustment position, your child is too large for this car seat.



Figure 83

See "Adjusting Headrest" on page 87 to change Headrest position.

Step 3

Check position of Crotch Strap:

- The Crotch Strap must be through the Crotch Strap Slot located at or behind and closest to the front of the child's crotch as shown in **Figure 84**. See "Crotch Strap Adjustment" on page 71 to change the position or length of the Crotch Strap.



Figure 84

- The Buckle Pad must be used for children weighing up to 22 lb (10 kg) as shown in **Figure 84a**.



Figure 84a

Step 4

Loosen Harness:

- While lifting up on Harness Adjuster Tab, pull out on Shoulder Harness Straps as shown in **Figure 85**.

NOTE: If the Harness cannot be adjusted large enough, switch the Metal Harness Plate to the lower sewn loops on Shoulder Harness Straps. See step 3 of "Shoulder Harness Rethreading" on page 77.

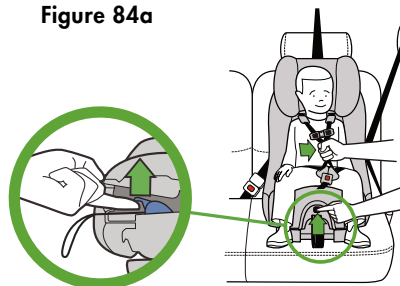

Figure 85

Step 5

Place child in car seat with their back flat against the Seat Back as shown in **Figure 86**.

Step 6

Place child's arms through Shoulder Harness Straps and position the Harness Straps over child's shoulders and thighs.

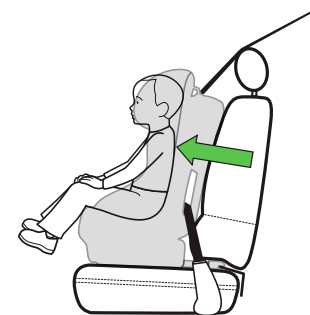

Figure 86

Step 7

Buckle Harness:

- Insert Buckle Tongues into Buckle one at a time as shown in **Figure 87**. You should hear a click.
- Pull up on tongues to check that they are securely locked.

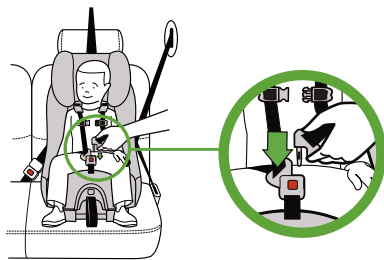

Figure 87

Step 8

Pull Harness Adjuster Strap to snugly adjust Harness Straps as shown in **Figure 88**.

- Check that Harness Straps are snug on shoulder and thighs.
- A snug Harness should not allow any slack. It lies in a relatively straight line without sagging. It does not press on the child's flesh or push the child's body into an unnatural position.

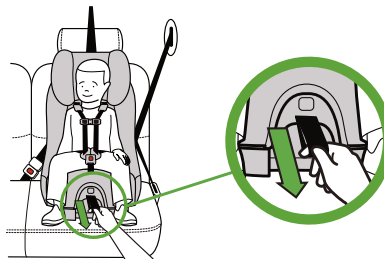

Figure 88

NOTE: If Harness cannot be snugly adjusted as described above, see step 3 of "Shoulder Harness Rethreading" on page 77 to make the harness smaller.

Step 9

Close Chest Clip and position Chest Clip at arm pit level as shown in **Figure 89**.

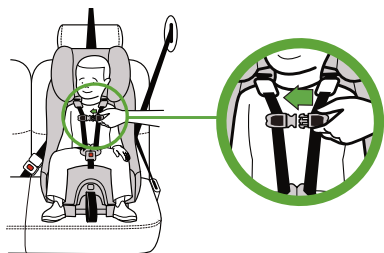

Figure 89

Removing Your Child from Car Seat

Step 1

Separate Chest Clip by squeezing release tabs together (1) and pulling Chest Clip apart (2) as shown in **Figure 90**.

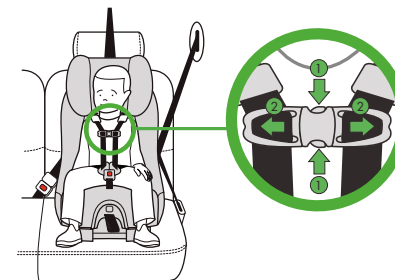

Figure 90

Step 2

Unbuckle Harness by pressing red release button on Buckle as shown in **Figure 91**.

Step 3

Loosen the Harness and remove child's arms from Harness and remove them from car seat.

NOTE: To keep the Harness out of the way for easier placement or removal of your child, place the Buckle Tongues between the fabric and the plastic panel on the exterior of the child seat.

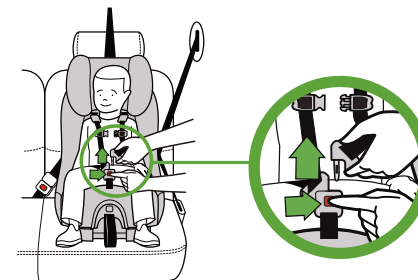

Figure 91

Operation and Adjustments

Crotch Strap Adjustment

Step 1

Remove the Seat Cushion, see “Removing/Installing Seat Cushion” on page 84.

Step 2

To move the Crotch Strap from one position to the other:

- Slide the Strap to one side of the Crotch Strap Slot and push the edge of the Strap into the adjustment slot as shown in **Figure 92**.
- Slide the Crotch Strap into the other Crotch Strap Slot as shown in **Figure 93**, ensuring that the red release button on the Buckle faces out of the seat as shown in **Figure 93a**.

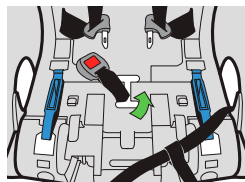

Figure 92

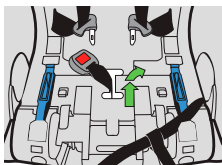

Figure 93

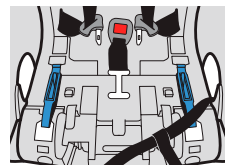

Figure 93a

Step 3

NOTE: For larger children, the Crotch Strap can be lengthened and installed in the forward Crotch Strap Slot.

IMPORTANT: NEVER use the longer Crotch Strap length in the rear Crotch Strap Slot.

TO LENGTHEN THE CROTCH STRAP

- Slide the belt to one side of the Crotch Strap Slot and push the edge of the belt into the adjustment slot as shown in **Figure 94**.
- Slide the crotch strap out of the Crotch Strap Slot as shown in **Figure 95**.
- Select the longer Crotch Strap length and slide the crotch strap into the outer Crotch Strap Slot as shown in **Figure 96**, ensuring that the red release button on the buckle faces out of the seat as shown in **Figure 97**.

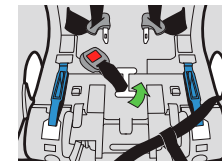

Figure 94

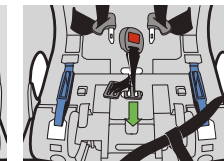

Figure 95

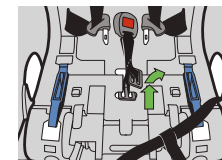

Figure 96

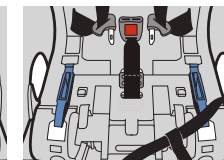

Figure 97

Step 4

Check position of Crotch Strap:

- The Crotch Strap must be through the Crotch Strap Slot located at or behind and closest to the front of the child's crotch as shown in **Figure 98**.



Figure 98

Step 5

Install the Seat Cushion, see "Removing/Installing Seat Cushion" on page 84.

Shoulder Harness Height Adjustment



WARNING – DEATH or SERIOUS INJURY can occur

- To prevent ejection in a crash, the loops at the end of the Shoulder Harness Straps must be properly attached to the Metal Harness Plate.
- To prevent loose Harness and risk of ejection in a crash, Harness must be properly routed under bottom of seat back cover.
- To prevent loose Harness and risk of ejection in a crash, the Shoulder Harness Straps must be routed through Shoulder Harness Slots at the same height on each side and in the pad and seat back.

Shoulder Harness Unthreading

Step 1

Unbuckle Harness Buckle and release Chest Clip.

Step 2

Loosen Harness to largest size:

- While lifting up on Harness Adjuster Tab, pull out on Shoulder Harness Straps until they stop as shown in **Figure 99**.

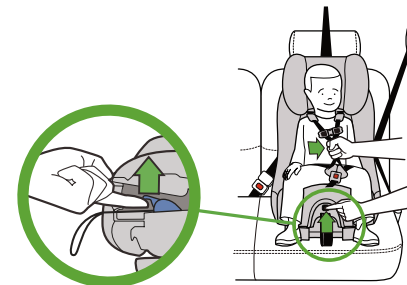

Figure 99

Step 3

Remove Shoulder Harness Access Panel from back of car seat:

- Twist the Access Panel lock counter-clockwise and pull to remove as shown in **Figure 100**.

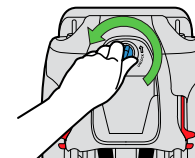

Figure 100

Step 4

Remove loops at ends of Shoulder Harness Straps from Metal Harness Plate by sliding strap out through slot in Metal Harness Plate as shown in **Figure 101**.

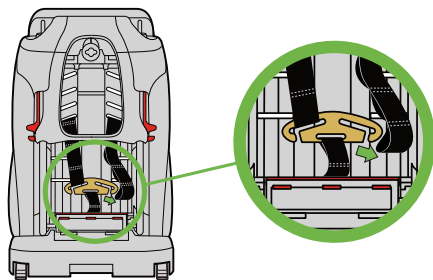

Figure 101

Step 5

From front of car seat, pull Shoulder Harness Straps out of seat back.

Shoulder Harness Slot Adjustment

For Rear-Facing Use: Insert the Shoulder Harness Straps through the Shoulder Harness Slots at or just below and closest to the shoulders of your child as shown in **Figure 102**.



Figure 102

For Forward-Facing Use: Insert the Shoulder Harness Straps through the Shoulder Harness Slots at or just above and closest to the shoulders of your child as shown in **Figure 103**.



Figure 103

Shoulder Harness Rethreading

Step 1

Check that Harness Straps are not twisted and from front of seat, insert Shoulder Harness Straps through the desired Shoulder Harness Slots as shown in **Figure 104**. Straps **MUST** go through the Shoulder Harness Slots at the same height on each side

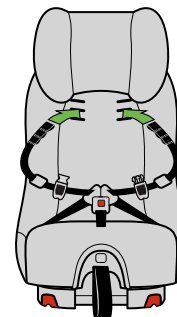

Figure 104

Step 2

Route Shoulder Harness under bottom of seat back cover (1) as shown in **Figure 105**.

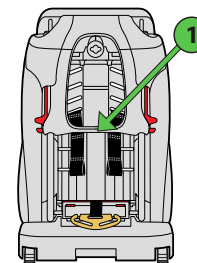

Figure 105

Step 3

Attach desired loops at end of Shoulder Harness Straps to Metal Harness Plate by sliding strap into slot in plate as shown in **Figure 106**.

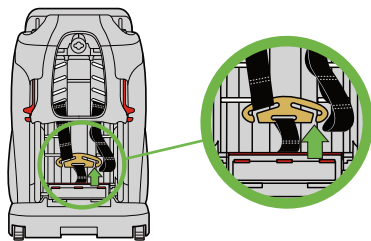

Figure 106

TO LENGTHEN THE SHOULDER HARNESS WEBBING

For larger children: to make the Harness larger, attach the Metal Harness Plate to a loop closer to the end of the Shoulder Harness Strap as shown in **Figure 107**.

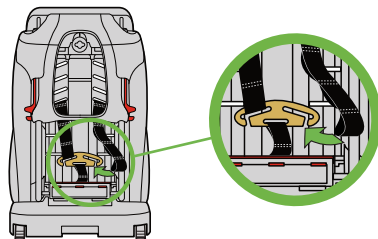

Figure 107

TO SHORTEN THE LENGTH OF THE SHOULDER HARNESS WEBBING

For smaller children: to make the Harness smaller, attach the Metal Harness Plate to a loop further in from the end of the Shoulder Harness Strap as shown in **Figure 108**.

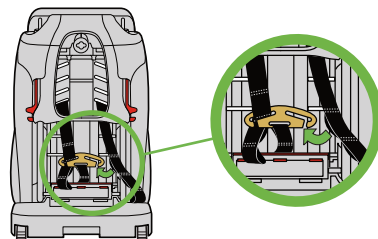

Figure 108

Check that both Shoulder Harness Straps are attached to the Metal Harness Plate on the same loop while ensuring that each Shoulder Harness Strap is completely inside the slot in metal Harness Plate as shown in **Figure 109**.

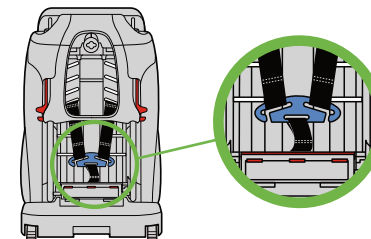

Figure 109

Step 4

Reattach Shoulder Harness Access Panel to back of car seat:

- Insert the access panel and twist the access panel lock clockwise as shown in **Figure 110**.

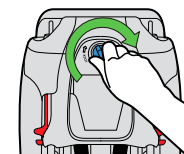

Figure 110

Shoulder Harness Cover Removal/Installation

The Shoulder Harness Covers included with this seat are optional.

Shoulder Harness Straps must be unthreaded in order to remove (or install) the Shoulder Harness Covers, and then rethreaded into the proper Shoulder Harness Slots. See “Shoulder Harness Adjustment” section on pages 73–78 for instructions on how to unthread and rethread the shoulder harness straps.

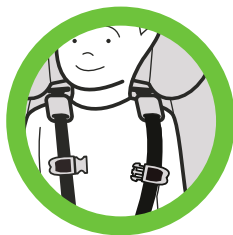

Figure 111



Figure 112

Installing/Removing Rear-Facing Base

TO INSTALL REAR-FACING BASE

Step 1

Place the car seat on a clean, stable surface with the inside of the seat facing down.

Step 2

Line the Rear-Facing Base Retention Hooks up with the openings in the bottom of the car seat, as shown in **Figure 113**. Insert the Rear-Facing Base Retention Hooks into the openings and slide the base down until you hear the Rear-Facing Base Release Lever “click” to lock the base on as shown in **Figure 114**.

Step 3

Pull up on Rear-Facing Base to check that it is locked in place.

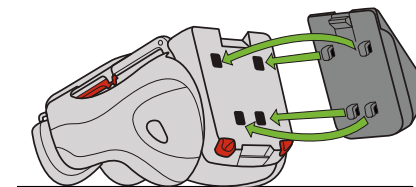

Figure 113

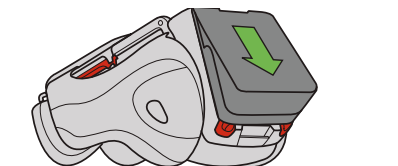

Figure 114

TO REMOVE REAR-FACING BASE

Step 1

Place the car seat on a clean, stable surface with the inside of the seat facing down.

Step 2

Pull Rear-Facing Base Release Lever away from the car seat and move the Rear-Facing Base up to release it as shown in **Figure 115**.

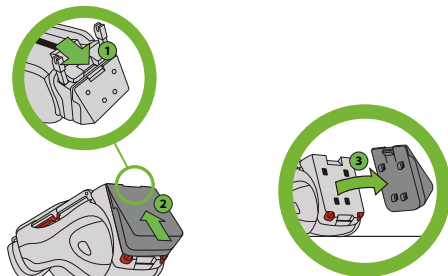

Figure 115

Installing/Removing Rear-Facing Anti-Rebound Bar

Step 1

Fully recline the seat to Recline Position 3 by pulling Recline Handle out and rotating car seat back as shown in **Figure 116**.

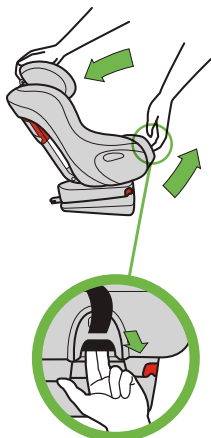

Figure 116

Step 2

Remove Seat Cushion, see "Removing/Installing Seat Cushion" on page 84.

Remove Rear-Facing LATCH Push-on Connectors from their storage location, see "Rear-Facing LATCH Storage" on page 88.

Step 3

Insert the Rear-Facing Anti-Rebound Bar into the holes in the bottom of the seat in front of the base as shown in **Figure 117**.

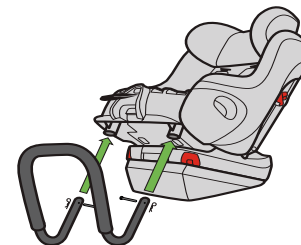

Figure 117

Step 4

Hold the Anti-Rebound Bar in place and insert Locking Pins into the holes in the seat and through the Anti-Rebound Bar as shown in **Figure 118**. Check that each Locking Pin is securely installed through both sides of the Anti-Rebound Bar and that the Locking Pin Clip are through the Locking Pins.

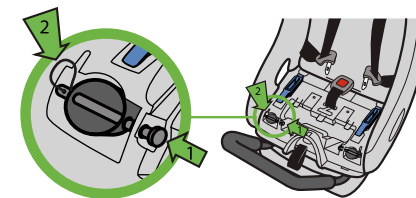

Figure 118

Step 5

If installing with vehicle belt, place Rear-Facing LATCH Push-on Connectors back into their storage location, see "Rear-Facing LATCH Storage" on page 88.

TO REMOVE REAR-FACING ANTI-REBOUND BAR

Step 1

Remove the Seat Cushion, see "Removing/Installing Seat Cushion" on page 84.

If LATCH Push-on Connectors are stored, remove them from their storage location, see "Rear-Facing LATCH Storage" on page 88.

Step 2

Remove the Locking Pins and Locking Pin Clips from the seat as shown in **Figure 119**. The bar should slide down until it comes completely out of the seat.

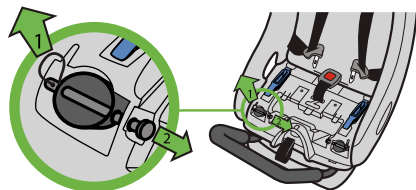

Figure 119

Step 3

Keep Locking Pins and Locking Pin Clips with Anti-Rebound Bar for storage.

Step 4

Place LATCH Push-on Connectors back into their storage location, see "Rear-Facing LATCH Storage" on page 88.

Install the Seat Cushion, see "Removing/Installing Seat Cushion" on page 84.

Removing/Installing Seat Cushion

! WARNING – DEATH or SERIOUS INJURY can occur

- Never use this car seat without the Seat Cushion in place.

TO REMOVE SEAT CUSHION

Unfasten the locking tabs at the lower front edge of the seat cushion.

Grasping Seat Cushion at the bottom front edge, lift and pull forward as shown in **Figure 120**. Once the Seat Cushion releases, pull the Buckle through the Seat Cushion.

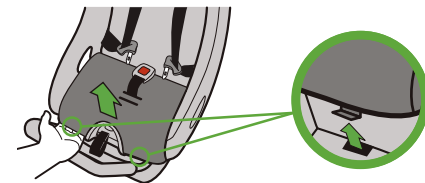

Figure 120

TO INSTALL SEAT CUSHION

Step 1

Insert the Buckle through the slot in the Seat Cushion that matches the slot the Crotch Strap is through in the seat.

Step 2

Insert the tabs on the back of the Seat Cushion through the slots in the pad and into the seat back at the back of the seat bottom.

Push the locking tabs at the lower front of the Seat Cushion into the holes at the front edge of the seat as shown in **Figure 121**.

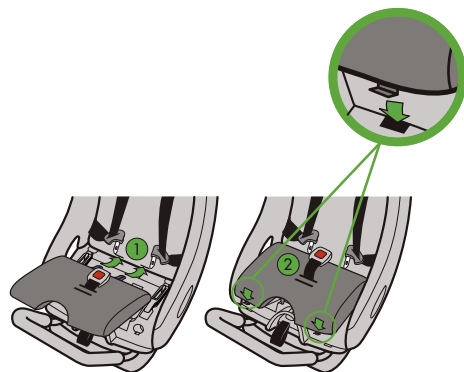

Figure 121

Installing/Adjusting Headrest

⚠ WARNING – DEATH or SERIOUS INJURY can occur

- Never use this seat without the Headrest.

INSTALLING HEADREST

Insert the Headrest support rods into the Headrest guides in the top of the seat back as shown in **Figure 122** and push the Headrest down until it locks into position.

NOTE: It may be necessary to rock the Headrest back and forth from front to back in order to get the support rods into the guides.

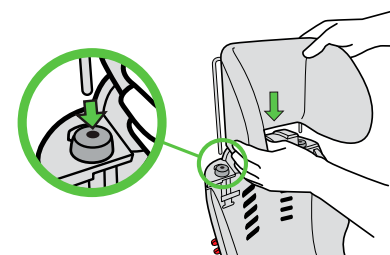

Figure 122

Adjusting Headrest

Step 1

Press the button on the Headrest Adjuster on the right-hand side of the seat (when facing front of seat) (1) and raise or lower the Headrest into the desired position (2) as shown in **Figure 123**.

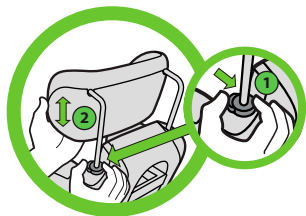

Figure 123

Step 2

Check for proper adjustment of Headrest.

The bottom of the Headrest must always be at or above the Harness Slots in use.

Rear-Facing: The top of the child's head must be at least 1" (2.5 cm) below the top of the car seat's Headrest, as shown in **Figure 124**. If the top of the child's head is less than 1" (2.5 cm) below the top of the Headrest in the highest adjustment position, your child is too large for using this car seat Rear-Facing and must be transitioned to Forward-Facing use with this car seat.

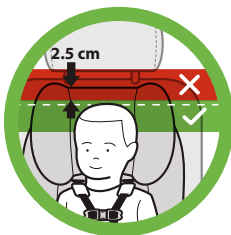

Figure 124

Forward-Facing: The tops of the child's ears **MUST** be below the top of the car seat's Headrest, as shown in **Figure 125**. If the tops of the child's ears are above the top of this car seat's Headrest in the highest adjustment position, your child is too large for this car seat.



Figure 125

Rear-Facing LATCH Storage

REMOVAL OF LATCH FROM STORAGE

Step 1

Remove the Seat Cushion, see "Removing/Installing Seat Cushion" on page 84.

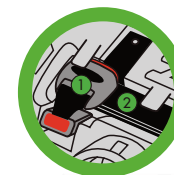

Step 2

Remove the Rear-Facing LATCH Adjusters (1) and Belt (2) from their storage position in the seat bottom shown in **Figure 126**.

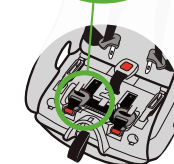

Figure 126

Step 3

Push and hold red release button on Rear-Facing LATCH Push-on Connectors and pull out as shown in **Figure 127**.

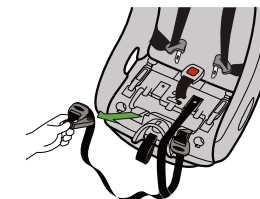

Figure 127

STORAGE OF REAR-FACING LATCH

Step 1

Remove the Seat Cushion, see "Removing/Installing Seat Cushion" on page 84.

Step 2

Insert the Rear-Facing LATCH Push-on Connectors, with the slots in the end oriented toward the outside of the seat, into the openings at the front of the seat bottom, as shown in **Figure 128**.

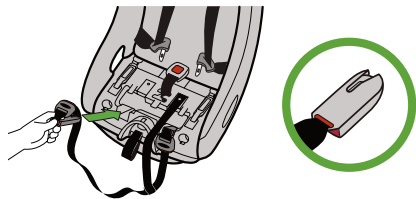

Figure 128

Step 3

Insert the Rear-Facing LATCH Adjusters (1) into the square recesses behind the LATCH Push-on Connectors, fold the excess LATCH Belt (2) and insert under tab between adjusters as shown in **Figure 129**.

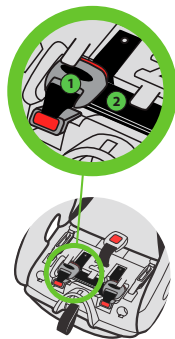

Figure 129

Step 4

Install the Seat Cushion, see "Removing/Installing Seat Cushion" on page 84.

Forward-Facing Rigid LATCH Storage

To store the Rigid LATCH Connectors, pull and hold the Rigid LATCH Adjustment Handle while pulling the Rigid LATCH Lower Connectors into the seat until they stop as shown in **Figure 130**.

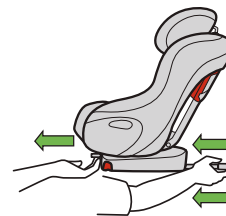

Figure 130

Top Tether Storage

Removal: Remove Instruction Manual and Top Tether from back of seat. Pull in and hold retention spring on Tether Hook, then remove Tether Hook from storage bar as shown in **Figure 131**, then replace Instruction Manual.

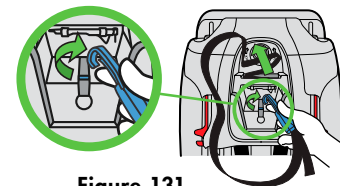

Figure 131

Storage: Remove Instruction Manual from back of seat. Hook Tether Hook around storage bar as shown in **Figure 132**, fold Top Tether belt and insert into Tether Storage. Replace Instruction Manual.

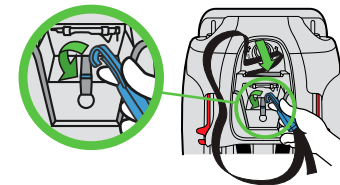

Figure 132

Instruction Manual Storage

After carefully reading and following these instructions, keep this manual for future use and store in the compartment located in Shoulder Harness Shield, as shown in **Figure 133**.

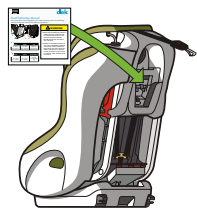

Figure 133

Removing/Installing Seat Cushion Cover

Step 1

Remove the Seat Cushion from the Seat, see "Removing/Installing Seat Cushion" on page 84.

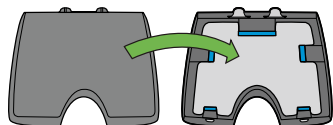

Figure 134

Step 2

Turn Seat Cushion over to locate the Seat Cushion Cover attachments, as shown in **Figure 134**.

Step 3

Using your thumb, push inward on each Seat Cushion Cover attachment one at a time to release the Cover from the Seat Cushion, as shown in **Figure 135**.

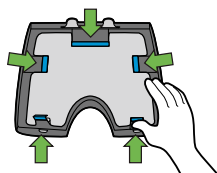

Figure 135

Step 4

Remove Seat Cushion Cover from Seat Cushion, as shown in **Figure 136**.

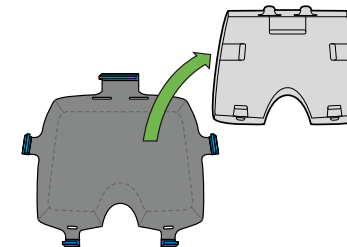

Figure 136

TO INSTALL SEAT CUSHION COVER

Step 1

Place Seat Cushion Cover on a flat surface with Seat Cushion Cover attachments facing up, as shown in **Figure 137**.

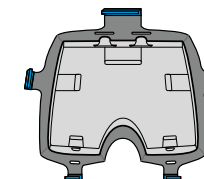

Figure 137

Step 2

Place Seat Cushion onto Seat Cushion Cover, aligning the Seat Cushion with the Seat Cushion Cover attachments.

Step 3

Reattach Seat Cushion Cover attachments to Seat Cushion by wrapping the Seat Cushion Cover sides around the entire Seat Cushion, as shown in **Figure 138**.

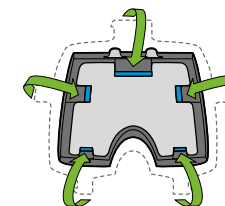

Figure 138

SEAT BACK COVER REMOVAL/INSTALLATION

Removal of the seat back cover is not recommended unless necessary due to heavy soiling which cannot be removed by surface washing. For instructions on removal and installation of the seat back cover go to <http://www.clekinc.com/support/foof>

Aircraft Installation

Clek strongly recommends that children are secured in their child seat during airline travel.

FORWARD FACING

To install this seat in an aircraft Forward-Facing, follow the instructions for installing the seat with a lap belt in the "Installing Forward-Facing Car Seat With Vehicle Belt" section on page 57.

IMPORTANT: Aircraft are not equipped with top tether anchors. The Top Tether should be stored in the back of the car seat and not used on an aircraft, see "Top Tether Storage" on page 90.

REAR FACING

To install this seat in an aircraft Rear-Facing, follow the instructions for installing the seat with a lap belt in the "Installing Rear-Facing Car Seat With Vehicle Belt" section on page 35.

IMPORTANT: The Rear-Facing Base and Anti-Rebound Bar **MUST** be used when installing this car seat rear facing in an aircraft.

NOTE: If it is necessary to check your seat, it must be packed in a Clek Weelee Travel Bag (sold separately). Damage may result from checking your seat without proper packaging.

Care and Cleaning

CAR SEAT FABRIC WASHING INSTRUCTIONS

Step 1

If the spot has dried, try lightly brushing or scraping off the residue. Wipe surface with water.

Step 2

If a spot still remains, apply a mild detergent to fabric with a light mist.

Step 3

Work area using soft brush or edge of spoon from outside of spot towards the middle.

Step 4

Allow solution to work for approximately one minute.

Step 5

Remove with clean water or blot with clean soft towel.

Step 6

Repeat steps 3-5 as necessary until spot is removed.

Step 7

Rinse with clear lukewarm water and blot with clean soft white cloth as final step.

SEAT FRAME (EXTERIOR PLASTICS ONLY) WASHING INSTRUCTIONS

Use a soft cloth with warm water and soap. Apply light pressure with cloth in small circular motions.

Do NOT remove the labels from this car seat. They are meant to be permanent so they can remind you and others of important information. Removal will mar the finish of the seat.

HARNESS WASHING INSTRUCTIONS

Surface wash straps with a damp cloth using warm water and a mild detergent.

BUCKLE WASHING INSTRUCTIONS

Buckle may be rinsed under warm water. Do not use detergents or lubricants.

RECYCLING YOUR SEAT

For instructions on how to recycle your Clek Foonf child seat, please visit <http://www.clekinc.com/recycle/>

Troubleshooting

For instructions on troubleshooting your Clek Foonf child seat, please visit <http://www.clekinc.com/support/foonf>

Accessories

Optional accessories for this product may be purchased at: <http://www.shopclek.com>

Warranty

LIMITED WARRANTY

Clek Inc. warrants, only to the original consumer purchaser and only if this product was purchased (new and unused in an unopened box) from an authorized Clek retailer listed at www.clekinc.com, that this product will be free from defects in material and workmanship for one (1) year from the date of original purchase (the "Warranty Period"). During the Warranty Period, Clek Inc. will, at its option, repair or replace this product if it is found by the manufacturer to be defective in material or workmanship. Clek Inc. reserves the right to discontinue or change parts, fabrics, models, or products, or to substitute this product with a comparable model or product. To make a claim under this warranty, please contact us at http://www.clekinc.com/contact_us/, call us at 1-866-656-2462, or write to us at Clek Inc., Attn: Customer Service, Clek Inc., 226 Lesmill Road, Toronto, Ontario, Canada M3B 2T5. An original receipt is required to validate your warranty and shipping charges will be the responsibility of the original consumer purchaser. To expedite the processing of any future warranty claims and to verify the original date of purchase, please complete and mail the pre-addressed owner registration card within thirty (30) days of purchase.

WARRANTY LIMITATIONS

This warranty does not cover the effects of normal wear and tear or damage resulting from negligence, modification, improper installation, accidents, misuse or abuse of this product. It is expressly agreed that the obligations of Clek Inc. and the original consumer purchaser's remedies under the limited warranty contained herein are exclusive and are strictly limited to the repair or replacement of the product. This limited warranty is conditional upon strict compliance with the provisions of the Instruction Manual. In no event will Clek Inc. or the dealer selling this product be liable to you for any damages, including incidental or consequential damages, arising out of the use or inability to use this product.

LIMITATION OF WARRANTIES AND STATE/PROVINCIAL LAW RIGHTS

The warranty and remedies as set forth above are exclusive and in lieu of all others, oral or written, express or implied. To the extent permitted by applicable law, any implied warranties, including implied warranties of merchantability and fitness for a particular purpose, are hereby disclaimed. Some states/provinces DO NOT allow limitations as to how long an implied warranty lasts or the exclusion or limitation of incidental or consequential damages, so the above limitations may not apply to you. This warranty gives you specific legal rights, and you may have other rights, which vary from state/province to state/province. Neither Clek Inc. nor the dealer selling this product has authorized any person to create for it any other warranty, obligation, or liability in connection with this product.

How To Receive Spanish Instructions

This instruction manual is also available in Spanish. To request a copy to be sent to you free of charge, please contact Clek Customer Service at 1-866-656-2462 or email us at customerservice@clekinc.com. You can also download a copy of the Foonf instruction manual in Spanish online at http://clekinc.com/pdfs/foonf_Owners_Manual_US_ES.pdf

Cómo recibir las instrucciones en español

Este manual de instrucciones también está disponible en español. Para pedir que se le envíe una copia sin cargo alguno, tenga a bien ponerse en contacto con el servicio al cliente de Clek, para lo cual llame al 1-866-656-2462 o envíe un mensaje de correo electrónico a customerservice@clekinc.com. También puede descargar una copia del manual de instrucciones de Foonf en español por Internet en http://clekinc.com/pdfs/foonf_Owners_Manual_US_ES.pdf

Keep this Instruction Manual for future use.
Store in Shoulder Harness Access Panel on back of this car seat.

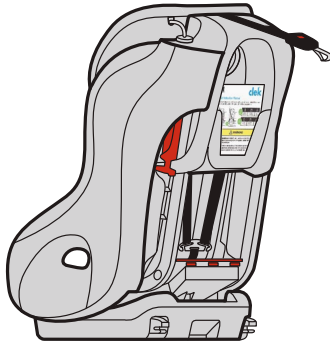

www.clekinc.com

Clek Inc.
226 Lesmill Road
Toronto, Ontario Canada
M3B 2T5
1-866-656-2462