



LI24USB1

clek

## Liing Instruction Manual



HEIGHT	WEIGHT
32 in. (or less) 81.3 cm (or less)	4–30 lb 1.8–13.6 kg

Keep instructions for future use.

Store in the Instruction Manual Storage Slot in Car Seat Base.

E01-2533-B1-US



### WARNING

- Read and understand all information and instructions on product labels and in this manual and in your vehicle owner's manual before installing or using this car seat/infant carrier.
- Failure to properly install or use this car seat or follow the warnings in this manual and on the car seat's labels can result in serious injury or death to the child in a sharp turn, sudden stop or crash.

January 2024

# Checklist for Proper Use

**IMPORTANT:** This is only a checklist — you **MUST** read and understand all of the warnings and instructions on this car seat's labels and in this manual before installing or using this car seat or carrier.

## General Use Requirements:

- ✓ Child weighs between 4 and 30 lb (1.8 and 13.6 kg).
- ✓ Child's height is 32 in. (81.3 cm) or less.
- ✓ The top of the child's head is at least 1 in. (2.5 cm) below the top of the Carrier Seat Back.
- ✓ Shoulder Harness Straps **MUST** be through Shoulder Harness Slots at or just below and closest to child's shoulders.
- ✓ Newborn Support Cushion **MUST** be used with infants 11 lb (5 kg) or less and if top of shoulders are below lowest Shoulder Harness Slots.
- ✓ Headrest **MUST** be used at all times.

## When installing this Car Seat with the Base:

- ✓ Car Seat is securely installed in a vehicle rear seat.
  - If car seat must be installed in a front seat, the front air bag for that position MUST be deactivated and the vehicle owner's manual MUST state that this is an acceptable position to install a rear-facing car seat.
- ✓ Base is securely attached to the vehicle using the LATCH Connectors or a vehicle belt.
- ✓ Base is installed with the Load Leg, and Load Leg is adjusted so the Load Leg Pressure Indicator is green.
  - If not able to use Load Leg, it is recommended to install with vehicle belt. ALWAYS store the Load Leg when not in use.
- ✓ Base is adjusted to the correct recline adjustment position for the child's weight.
- ✓ Carrier is securely attached to the Base, and Release Handle on the front of the Base is in closed position with no red visible.
- ✓ Harness is buckled and snugly adjusted on the child.
- ✓ Carry Handle is adjusted to and locked in the upright position.

## When installing this Car Seat without the Base:

- ✓ Carrier is securely installed in a vehicle rear seat.
  - If Carrier must be installed in a front seat, the front air bag for that position MUST be deactivated and the vehicle owner's manual MUST state that this is an acceptable position to install a rear-facing car seat.
- ✓ Carrier is securely attached to the vehicle using a vehicle belt and there is no slack in the belt.
  - If installing with a lap/shoulder belt, the vehicle lap belt is routed through both blue Lap Belt Guides, and the vehicle shoulder belt is wrapped around the back of the Carrier and through the blue Shoulder Belt Guide.
  - If installing with a lap-only belt, the vehicle lap belt is routed through both blue Lap Belt Guides.
- ✓ Blue recline reference line on side of Carrier is level with the ground.
- ✓ Harness is buckled and snugly adjusted on the child.
- ✓ Carry Handle is adjusted to and locked in the upright position.

## **When using this Carrier outside of the vehicle:**

- ✓ Harness is buckled and snugly adjusted on the child. If the straps are loosely buckled or unbuckled, the infant can fall out or strangle on Harness.
- ✓ Carry Handle is locked in the upright position before lifting Carrier by the Handle.
- ✓ Carrier is securely attached to the stroller.
- ✓ If not securely attached to a stroller or being carried, Carrier **MUST** be placed on the floor.
  - NEVER place Carrier on an elevated surface, it can fall injuring the child.
  - NEVER place Carrier on a soft surface where it can roll over suffocating the child.
- ✓ NEVER leave child unattended.
- ✓ NEVER place Carrier on shopping cart. If you must use Carrier in a store, Carrier may be placed inside the large part of the shopping cart (where it can't fall), or securely attached to a compatible stroller.

# Table of Contents

<b>Checklist for Proper Use</b> .....	2
General Use Requirements.....	2
When installing this Car Seat <u>with</u> the Base .....	3
When installing this Car Seat <u>without</u> the Base .....	4
When using this Carrier outside of the vehicle .....	5
<b>Car Seat Features</b> .....	8
<b>Registration &amp; Recall Information</b> .....	10
Registering Your Car Seat.....	11
<b>Warnings</b> .....	12
<b>Certification</b> .....	17
<b>Vehicle Classification</b> .....	17
<b>Child Size Requirements</b> .....	18
<b>Adjusting Car Seat to Fit Your Child</b> .....	20
Changing Shoulder Harness Height .....	20
Selecting the Correct Shoulder Harness Slot .....	21
Unthreading the Shoulder Harness .....	21
Rethreading the Shoulder Harness.....	23
Using the Newborn Support Cushion .....	26
Shoulder Harness Cover Removal/Installation.....	28
<b>Securing Your Child in Car Seat</b> .....	29
<b>Removing Your Child from Car Seat</b> .....	35
<b>Operation and Adjustments</b> .....	37
Carry Handle Adjustment .....	37
Removing Carrier from Car Seat Base .....	39
Adjusting the Canopy .....	40

<b>Vehicle Information</b> .....	<b>41</b>
Vehicle Child Restraint Anchorage System (LATCH) .....	41
Vehicle Seat Location Requirements .....	42
Vehicle Belt Requirements .....	45
Vehicle Belt Systems .....	46
<b>Installing/Removing Car Seat <u>with</u> Base</b> .....	<b>51</b>
Installing Car Seat Base with LATCH .....	53
Removing Car Seat Base Installed with LATCH .....	61
Installing Car Seat Base with Vehicle Belt .....	64
Removing Car Seat Base Installed with Vehicle Belt .....	74
<b>Installing/Removing Car Seat <u>without</u> Base</b> .....	<b>77</b>
Installing Car Seat without Base with Vehicle Belt .....	79
Removing Car Seat without Base Installed with Vehicle Belt .....	86
<b>Using Carrier Outside of the Vehicle</b> .....	<b>87</b>
Using Carrier on Stroller .....	88
Installing Carrier on Stroller .....	89
Releasing Carrier from Stroller .....	92
<b>Aircraft Installation</b> .....	<b>93</b>
<b>Care and Cleaning</b> .....	<b>94</b>
Car Seat Cleaning .....	94
Removing/Installing Carrier Cover .....	96
Recycling Your Car Seat .....	108
<b>Troubleshooting</b> .....	<b>108</b>
<b>Accessories</b> .....	<b>108</b>
<b>Warranty</b> .....	<b>109</b>

# Car Seat Features – Carrier

- 1 Shoulder Harness Slots
- 2 Shoulder Harness Covers
- 3 Shoulder Harness Straps
- 4 Chest Clip
- 5 Buckle Tongues
- 6 Buckle
- 7 Crotch Strap
- 8 Buckle Pad
- 9 Harness Adjuster Access Slot
- 10 Harness Adjuster Tab
- 11 Harness Adjuster Strap
- 12 Vehicle Lap Belt Guides
- 13 Carry Handle
- 14 Carry Handle Adjustment Buttons
- 15 Canopy
- 16 Stroller Release Handle (to release Carrier from stroller)
- 17 Vehicle Shoulder Belt Guide
- 18 Metal Harness Plate
- 19 Base Attachment Bars
- 20 Stroller Attachment Points
- 21 Inner Shell Release Tabs
- 22 Harness Anchor Plates
- 23 Newborn Support Cushion
- 24 Headrest
- 25 Carrier Cover
- 26 Carrier Cover Zipper (select models)

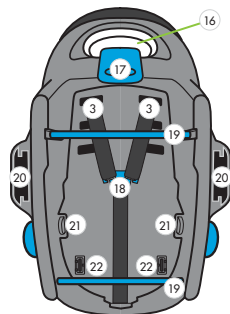
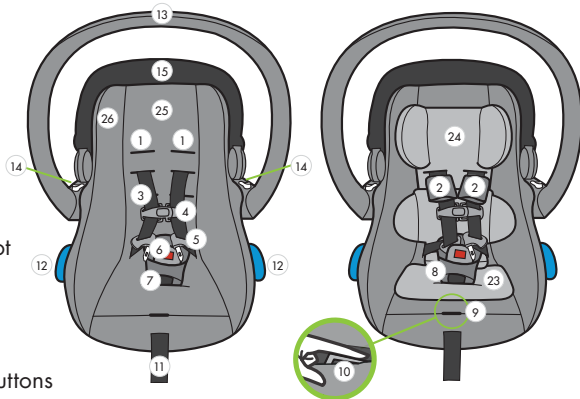



# Car Seat Features – Base

- 27 Vehicle Belt Guides
- 28 Belt Tensioner
- 29 Belt Tensioner Release Handle
- 30 Belt Tensioner Lock Indicators
- 31 Recline Sled Adjustment Handle
- 32 Recline Indicator
- 33 LATCH Adjustment Buttons
- 34 LATCH Connectors
- 35 LATCH Lock Indicators
- 36 LATCH Release Buttons
- 37 Carrier Lock Tab
- 38 Release Handle  
(to release Carrier from Base)
- 39 Load Leg
- 40 Load Leg Adjustment Handle
- 41 Load Leg Pressure Indicator
- 42 Load Leg Storage
- 43 Instruction Manual Storage Slot
- 44 Recline Sled

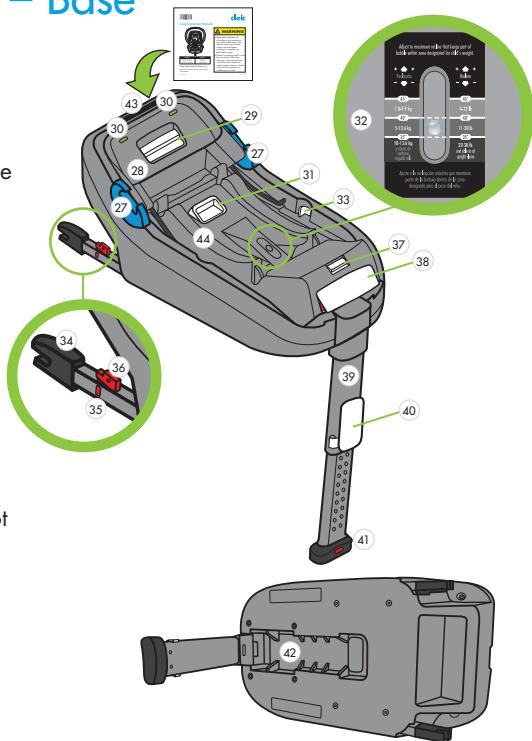

## Registration & Recall Information



### **WARNING**

- You **MUST** register this restraint (car seat) to be reached in a recall. Child restraints could be recalled for safety reasons.

Model Name: **LIING** \_\_\_\_\_

Serial Number: \_\_\_\_\_

Date of Manufacture: \_\_\_\_\_

(yyyy/mm/dd)

Date of Purchase: \_\_\_\_\_

## Registering Your Car Seat

Please fill in the information on the previous page for your records. The model name, serial number and manufacturing date can be found on a label affixed to the bottom of the Carrier.

**Fill out the prepaid registration postcard attached to the car seat and mail it today.**

Child restraints could be recalled for safety reasons. You **MUST** register this restraint to be reached in a recall. Send your name, address, e-mail address if available, and the restraint's model number and manufacturing date to:

Clek Inc.  
226 Lesmill Road  
Toronto, Ontario, Canada M3B 2T5  
or call 1-866-656-2462  
or register online at: [www.clekinc.com/register](http://www.clekinc.com/register)

For recall information, call the U.S. Government's Vehicle Safety Hotline at 1-888-327-4236 (TTY: 1-800-424-9153), or go to: [www.NHTSA.gov](http://www.NHTSA.gov)

## Warnings

### **WARNING – DEATH or SERIOUS INJURY can occur**

- Failure to properly install or use this car seat or follow these warnings and instructions and those on this car seat's labels can result in serious injury or death of the child in a sharp turn, sudden stop or crash.
- DO NOT install or use this car seat until you read and understand the instructions in this manual and in your vehicle owner's manual. DO NOT let others install or use this car seat unless they understand how to correctly install and use it.
- Use only in a Rear-Facing position when using this car seat in a vehicle. Serious or crippling injury or death can result if infant faces front of vehicle.
- Use only with children who weigh between 4 and 30 lb (1.8 and 13.6 kg) and whose height is 32 in. (81.3 cm) or less.

 **WARNING – DEATH or  
SERIOUS INJURY can occur (continued)**

- Securely install this child restraint system rear-facing on a forward-facing vehicle seat using the lower connector system of the Child Restraint Anchorage System (LATCH), if available, or a vehicle seat belt.
- Discontinue use of this Car Seat when:
  - Child's weight exceeds 30 lb (13.6 kg)
  - Child's height exceeds 32 in. (81.3 cm)
  - Child's head is less than 1 in. (2.5 cm) below top of Carrier Seat Back.
- ALWAYS check that the Carry Handle is locked in the Upright Position before lifting Carrier by the Handle. An unlocked handle could move unexpectedly, causing a child to fall.
- NEVER leave child unattended. ALWAYS keep child in view even when napping. DO NOT allow child to sleep unattended in this car seat or carrier.

# **WARNING – DEATH or SERIOUS INJURY can occur (continued)**

- Strangulation Hazard: Children have **STRANGL**ED in loose or partially buckled Harness Straps. Fully restrain the child even when Carrier is used outside the vehicle.
- Fall Hazard: Child's activity can move Carrier. **NEVER** place Carrier on counter tops, tables, or any other elevated surface.
- Suffocation Hazard: Carrier can roll over on soft surfaces and suffocate child. **NEVER** place Carrier on beds, sofas, or other soft surfaces.
- **NEVER** leave child unattended. **ALWAYS** keep infant in view even when napping. **DO NOT** allow infant to sleep unattended in this car seat.
- **NEVER** tend to your child's needs while driving. **ALWAYS** safely stop your vehicle to tend to your child's needs.
- **NEVER** take child out of Car Seat when vehicle is moving.



 **WARNING – DEATH or  
SERIOUS INJURY can occur (continued)**

- NEVER place Carrier on a shopping cart. Carrier may be placed inside large basket of shopping cart (where it can't fall), or securely attached to a compatible stroller.
- NEVER place Carrier near a window where cords from blinds or drapes can strangle a child.
- DO NOT use this Car Seat Base or Carrier after a crash of any kind. A crash can cause damage to this car seat that you cannot see.
- Discontinue use of Car Seat Base or Carrier after nine (9) years from the date of manufacture. The date of manufacture can be found on the label affixed to the bottom of the Carrier.
- DO NOT use accessories or parts with this car seat other than those provided by Clek Inc. Use of accessories or parts from other manufacturers could alter the performance of this car seat.
- NEVER use this Car Seat Base or Carrier if it is damaged, broken or missing parts.

 **WARNING – DEATH or  
SERIOUS INJURY can occur (continued)**

- DO NOT attempt to make repairs to or otherwise modify or tamper with this car seat.
- NEVER use this car seat without the Headrest.
- NEVER use a second hand car seat or a car seat whose history you do not know.
- Register your car seat with Clek Inc.
- Avoid burn injury — ALWAYS touch the surfaces that will contact your child first before putting child in this car seat. This car seat can become very hot if left in the sun and can burn your child's skin.



## Certification

- This child restraint system conforms to all applicable Federal motor vehicle safety standards.
- This restraint is certified for use in Motor Vehicles and Aircraft.

**IMPORTANT:** Do NOT use with the Base on Aircraft. This restraint is certified for use in Aircraft only when used without the Base.

## Vehicle Classification

- This car seat is for use only in the following classes of vehicles: passenger cars, trucks, and multi-purpose vehicles, such as SUVs (sport utility vehicles).

## Child Size Requirements



### **WARNING**

- DO NOT use this car seat if the child does not meet all of the size requirements listed on the next page. Using this car seat with a child who does not meet these requirements will increase the risk of serious injury or death to the child.
- The American Academy of Pediatrics recommends that infants born before 37 weeks and/or those weighing less than 5.5 lb (2.5 kg) have a “car seat test” before going home from the hospital.

Child **MUST** meet ALL of the following requirements to use this car seat:

- ✓ Child weighs between 4 and 30 lb (1.8 and 13.6 kg).
- ✓ Child's height is 32 in. (81.3 cm) or less.
- ✓ The top of the child's head is at least 1 in. (2.5 cm) below the top of the Carrier Seat Back, as shown in **Figure 1**.

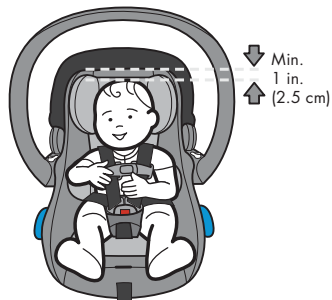

**Figure 1**

- ✓ Shoulder Harness Straps **MUST** be through Shoulder Harness Slots at or below and closest to child's shoulders, as shown in **Figure 2**.
- ✓ Newborn Support Cushion **MUST** be used with infants 11 lb (5 kg) or less and if top of shoulders are below lowest Shoulder Harness Slots.



**Figure 2**

- ✓ Headrest **MUST** be used at all times.

# Adjusting Car Seat to Fit Your Child

## Changing Shoulder Harness Height



### **WARNING**

- To prevent ejection in a crash, Shoulder Harness Straps **MUST** be through the Shoulder Harness Slots at or just below and closest to the child's shoulders and through Harness Slots in Headrest.
- To prevent ejection in a crash, the loops at the end of the Shoulder Harness Straps **MUST** be completely inside the Metal Harness Plate.
- To prevent carrier separation from the Base or ejection in a crash, **NEVER** use this car seat if either the Shoulder Harness Straps or Harness Adjuster Strap is routed over the Base Attachment Bars.
- To prevent ejection in a crash, Newborn Support Cushion **MUST** be used if top of child's shoulders are below lowest Shoulder Harness Slots.
- Headrest **MUST** be used at all times.

This car seat ships with the Shoulder Harness Straps in the middle of three (3) Shoulder Harness Slots.

As the child grows, you will need to change the Shoulder Harness Slot position. The Shoulder Harness Straps **MUST** be through the Shoulder Harness Slots at or just below and closest to the child's shoulders. **NEVER** use with Shoulder Harness Straps positioned through Shoulder Harness Slots above the top of the child's shoulders.

## Selecting the Correct Shoulder Harness Slot

### Step 1

Place the child in the Carrier.

### Step 2

Check to see which is the appropriate Shoulder Harness Slot that fits the child. Choose the Slots at or just below and closest to the child's shoulders, as shown in **Figure 3**.

**NOTE:** You will need to pull the Headrest forward to expose the Shoulder Harness Slots in the Carrier to check the height of Harness Slots.



**Figure 3**

## Unthreading the Shoulder Harness

### Step 1

Buckle the Harness and close the Chest Clip to prevent the Shoulder Harness Straps from twisting.

## Step 2

Loosen the Harness:

- While pressing down on Harness Adjuster Tab, pull out on Shoulder Harness Straps to loosen Harness, as shown in **Figure 4**. The Harness Adjuster Tab is accessible through the slot sewn into the fabric between the Harness Adjuster Strap and the Crotch Strap.

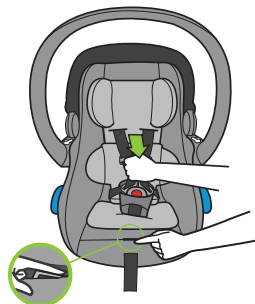

**Figure 4**

## Step 3

Turn Carrier over and detach the loop at the end of each Shoulder Harness Strap by sliding Strap out through the slot in Metal Harness Plate as shown in **Figure 5**.

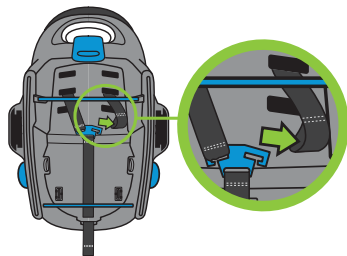

**Figure 5**

## Step 4

From front of Carrier, pull Shoulder Harness Straps out of Carrier Seat Back.

## Rethreading the Shoulder Harness

### Step 1

Insert the Shoulder Harness Straps through the Harness Slots in the Headrest, ensuring that the Straps are not twisted.

From front of Carrier, insert the Shoulder Harness Straps through the chosen Shoulder Harness Slots in the Carrier Seat Back as shown in **Figure 6**, ensuring that the Straps are not twisted.

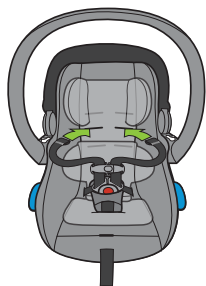
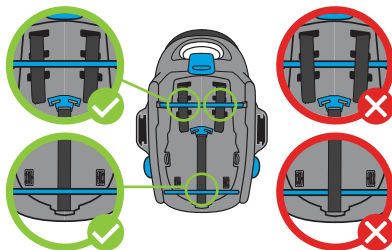

**Figure 6**

## Step 2

Re-attach the Harness:

- Route Shoulder Harness Straps and Harness Adjuster Strap between Base Attachment Bars and bottom of Carrier, as shown in **Figure 7**.



**Figure 7**

- Hold the silver Metal Harness Plate straight up ensuring there are no twists in the Harness Adjuster Strap, and slide the loop end of each Shoulder Harness Strap through the slot in the Metal Harness Plate, ensuring that each Strap is completely inside the slot as shown in **Figure 8**.

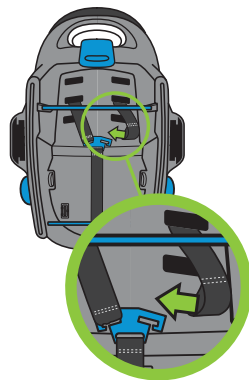
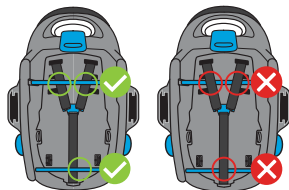

**Figure 8**



### Step 3

Check that both Shoulder Harness Straps and the Harness Adjuster Strap are routed between the Base Attachment Bars and the bottom of the Carrier as shown in **Figure 9**.



**Figure 9**

#### Checklist for Changing Shoulder Harness Slot:

- ✓ Shoulder Harness Straps are through the Shoulder Harness Slots in the Carrier Seat Back that are at or below and closest to the child's shoulders, and are at the same height on each side.
- ✓ End of each Shoulder Harness Strap is completely inside the slot in the Metal Harness Plate.
- ✓ Check that Shoulder Harness Straps and Harness Adjuster Strap are flat and NOT twisted.
- ✓ Shoulder Harness Straps and the Harness Adjuster Strap are routed between the Base Attachment Bars and the bottom of the Carrier and NOT over the Base Attachment Bars.

## Using the Newborn Support Cushion



# WARNING

- To prevent ejection in crash, the Newborn Support Cushion **MUST** be used with infants less than 11 lb (5 kg) and when top of shoulders are below lowest Shoulder Harness Slots.

This car seat ships with the Newborn Support Cushion installed.

### Proper Use of the Newborn Support Cushion:

- The Newborn Support Cushion **MUST** be used with infants weighing less than 11 lb (5 kg) and when top of shoulders are below lowest Shoulder Harness Slots.
- The Newborn Support Cushion can be used (optional) with children weighing 11 lb (5kg) or more and until the child's shoulders reach the top Shoulder Harness Slot. **NEVER** use the Newborn Support Cushion when the child's shoulders are at or above the top Shoulder Harness Slot with the Newborn Support Cushion installed.
- The Headrest **MUST** be used at all times.

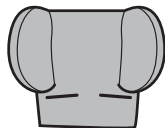

**Headrest  
(required)**

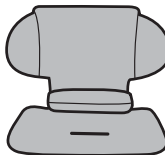

**Newborn  
Support  
Cushion**

## Newborn Support Cushion Removal/Installation:

**To Install:** Place the Newborn Support Cushion on the Carrier seating surface with the Buckle Slot aligned with the Crotch Buckle, and pull the Buckle and Buckle Pad up through the Buckle Slot in the Newborn Support Cushion, as shown in **Figure 10**.

**To Remove:** Lift the Newborn Support Cushion off of the Carrier seating surface, pull Buckle down through Buckle Slot in Newborn Support Cushion, and remove.

**IMPORTANT:** After removing the Newborn Support Cushion, it may be necessary to change the shoulder harness height. ALWAYS check that the Shoulder Harness Straps are through the Shoulder Harness Slots at or below and closest to the child's shoulders. See "Changing Shoulder Harness Height" section on **page 20**.

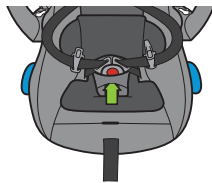

**Figure 10**

## Shoulder Harness Cover Removal/Installation

Use of the Shoulder Harness Covers included with this seat is optional.

**To Install:** Position Shoulder Harness Covers around Shoulder Harness Straps with snaps facing away from child's neck and fasten the snaps together to close as shown in **Figure 11**.

**To Remove:** Unfasten the snaps on the Shoulder Harness Covers and remove Shoulder Harness Covers.

**IMPORTANT:** Remove Shoulder Harness Covers if they prevent the Chest Clip from being properly positioned at armpit level or if you are unable to achieve a snug Harness.



**Figure 11**

## Securing Your Child in Car Seat



### WARNING

- Shoulder Harness Straps **MUST** be through the Shoulder Harness Slots at or just below and closest to the child's shoulders.
- Strangulation Hazard: Children have **STRANGLERD** in loose or partially buckled Harness Straps. Fully restrain the child even when Carrier is used outside the vehicle.
- Snugly adjust the belts provided with this child restraint around the child.
- Newborn Support Cushion **MUST** be used with infants 11 lb (5 kg) or less and when top of shoulders are below lowest Shoulder Harness Slots.
- **NEVER** use Newborn Support Cushion when child's shoulders are at or above the top Shoulder Harness Slots with the Newborn Support Cushion installed.
- Child **MUST** be dressed in clothing with arms and legs that will not interfere with buckling and snugly adjusting Harness.

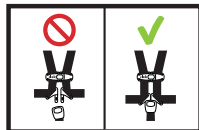



## WARNING (continued)

- NEVER place blankets between Harness and child.
- NEVER place extra padding under or behind the child. Extra padding or bulky clothing may prevent the Harness from being properly adjusted.
- Prevent death from heat exposure: NEVER leave child unattended in a vehicle, even when sleeping. Vehicle interiors can reach very high temperatures quickly, even when it is not a hot or sunny day.

### Step 1

Loosen Harness:

- Press down on Harness Adjuster Tab and pull out on Shoulder Harness Straps, as shown in **Figure 12**. The Harness Adjuster Tab is accessible through the slot sewn into the fabric between the Harness Adjuster Strap and the Crotch Strap.

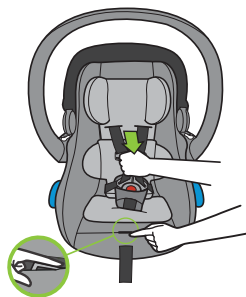

Figure 12

## Step 2

Place child in Carrier with back flat against Carrier Seat Back as shown in **Figure 13**. Make sure the child is NOT slouching.

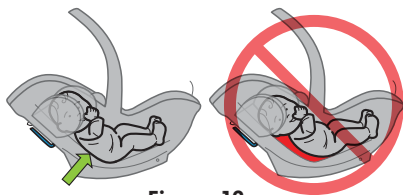

Figure 13

## Step 3

Place child's arms through Shoulder Harness Straps making sure the Straps go over the child's shoulders and hips as shown in **Figure 14**. The straps NEVER go under the child's legs.

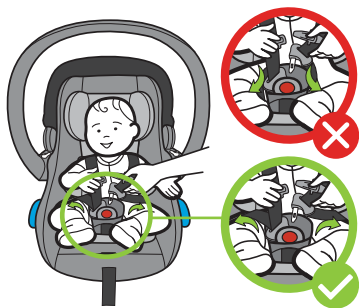

Figure 14

## Step 4

Check position of Shoulder Harness Straps:

- The Shoulder Harness Straps **MUST** be through Shoulder Harness Slots at or just below and closest to child's shoulders, as shown in **Figure 15**.

**NOTE:** Lift edge of Headrest to confirm selection of correct Shoulder Harness Slots.

See “Changing Shoulder Harness Height” on **page 20** to change position of Shoulder Harness Straps.



Figure 15

## Step 5

Buckle Harness:

- Insert Buckle Tongues into Buckle one at a time as shown in **Figure 16**. You should hear a click after each Buckle Tongue is inserted.
- Pull up on Buckle Tongues to check that they are securely locked.



Figure 16



## Step 6

Tighten Harness Straps:

- Pull upwards on Shoulder Harness Straps to remove any slack from the straps that goes over the hips/thighs, as shown in **Figure 17**.
- Pull Harness Adjuster Strap to remove slack in the Shoulder Harness Straps as shown in **Figure 18**.
- Repeat these steps several times until there is no more slack to pull out of the Shoulder Harness Straps.



Figure 17



Figure 18

## Step 7

Check that Shoulder Harness Straps are snug on both shoulders and hips/thighs. A snug strap should not allow any slack. It lies in a relatively straight line without sagging. It does not press on the child's flesh or push the child's body into an unnatural position.

The Shoulder Harness Straps are snug when you are unable to pinch a horizontal fold in the harness webbing at the child's shoulders, as shown in **Figure 19**.

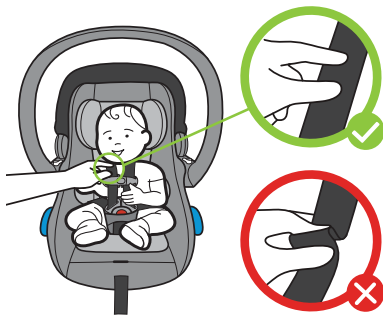
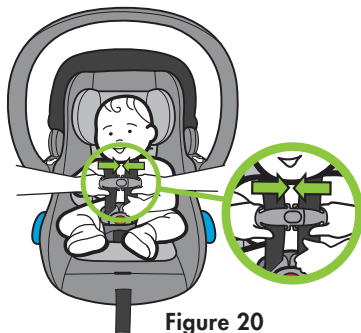

Figure 19

## Step 8

Close Chest Clip and position at arm pit level as shown in **Figure 20**.



**Figure 20**

Checklist for securing child:

- ✓ Newborn Support Cushion is being used if child weighs 11 lb (5 kg) or less and if top of shoulders are below lowest Shoulder Harness Slots.
- ✓ Child is NOT slouching and Shoulder Harness Straps go over the child's shoulders and hips.
- ✓ The top of the child's head is at least 1 in. (2.5 cm) below the top of the Carrier Seat Back.
- ✓ Shoulder Harness Straps routed through Headrest Harness Slots.
- ✓ Shoulder Harness Straps are through Shoulder Harness Slots at or below and closest to the top of the child's shoulders.
- ✓ Harness is buckled and snugly adjusted on child.
- ✓ Chest Clip is closed and is adjusted to arm pit level.

# Removing Your Child from Car Seat

To help achieve a snug Harness, the Shoulder Harness Straps should be loosened each time the child is removed from the seat and tightened each time the child is buckled in the seat.

## Step 1

Loosen Harness:

- While pressing down on Harness Adjuster Tab, pull out on Shoulder Harness Straps to loosen Harness, as shown in **Figure 21**. The Harness Adjuster Tab is accessible through the slot sewn into the fabric between the Harness Adjuster Strap and the Crotch Strap.



**Figure 21**

## Step 2

Separate Chest Clip:

- Press release tab in (1) and pull apart (2) to separate as shown in **Figure 22**.



Figure 22

## Step 3

Unbuckle Harness:

- Press red release button on Buckle as shown in **Figure 23**. Slide Shoulder Harness Straps off of shoulders and remove child from Carrier.



Figure 23

# Operation and Adjustments

## Carry Handle Adjustment



### WARNING

- ALWAYS check that the Carry Handle is locked in the Upright Position before lifting Carrier by the Handle. An unlocked handle could move unexpectedly, causing a child to fall.

The Carry Handle has three adjustment positions as shown in **Figure 24**: Upright (1), Stowed (2), Ground (3).

### Step 1

Select the proper Carry Handle Adjustment Position:

- **Using inside of the vehicle:** The Handle MUST be locked in the upright position.
- **Using outside of the vehicle:** The Handle may be used in any of the (3) adjustment positions, but MUST be locked in the upright position before lifting and when being carried.

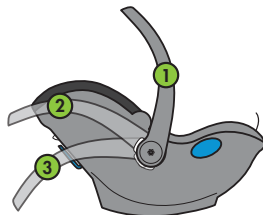

**Figure 24**

## Step 2

Adjust the Carry Handle Position:

- Press both Carry Handle Adjustment Buttons and rotate Handle until it locks in the desired position as shown in **Figure 25**.



Figure 25

## Removing Carrier from Car Seat Base

### Step 1

Use thumb to press down and hold Carrier Lock Tab (1). While holding the Carrier Lock Tab down, pull out and hold the Release Handle to the open position (2) as shown in **Figure 26**.

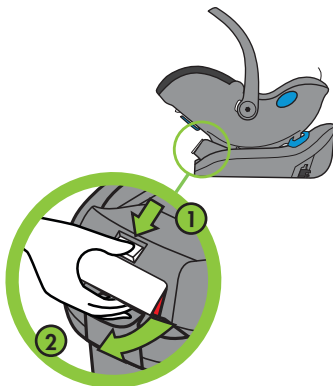

Figure 26

### Step 2

While holding Release Handle in the open position, use Carry Handle to lift Carrier off of Car Seat Base, as shown in **Figure 27**.

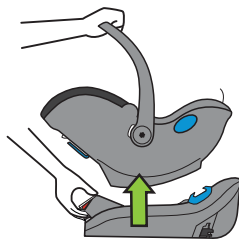

Figure 27

## Adjusting the Canopy

The Carrier has a 3-position Canopy. All Canopy positions are approved for use in vehicle or outside of vehicle.

To adjust the Canopy between the closed position (Position 1) and the open position (Position 2): grasp the front of the Canopy and pull it forward or rotate it back.

To fully extend Canopy: Grasp zipper tab and unzip the canopy extension. Then grasp front of Canopy and pull it forward to the fully-open position (Position 3), as shown in **Figure 28**.

**NOTE:** The canopy extension **MUST** be zipped closed when using either Position 1 or 2.

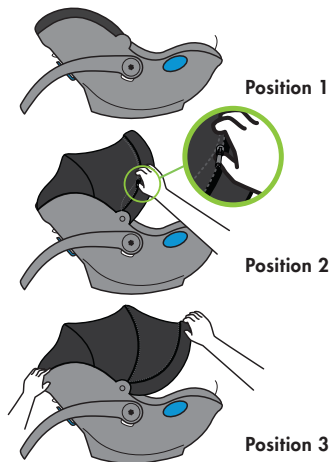

**Figure 28**



# Vehicle Information



## Vehicle Child Restraint Anchorage System (LATCH)

- LATCH stands for Lower Anchors and Tethers for Children. This term refers to the anchors built into a vehicle for attaching child restraints and consists of two lower anchors at the crease between the vehicle seat back and vehicle seat cushion and a top tether anchor behind the vehicle seat as shown in **Figure 29**.
- **LATCH Lower Anchors:** If not readily visible, the LATCH lower anchors may be noted by a symbol located near the crease between the vehicle seat back and vehicle seat cushion, as shown in **Figure 30**.
- **Top Tether Anchor:** If covered, the top tether anchor locations may be identified by a symbol as shown in **Figure 31**.

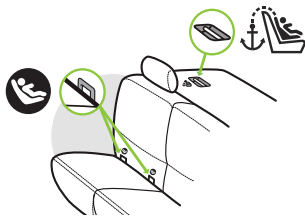

Figure 29



Figure 30



Figure 31

- 2003 or newer model year vehicles have at least two seating locations with a LATCH Anchorage System. Some 2001 and 2002 model year vehicles have LATCH Anchorage Systems. 2000 model year vehicles or older DO NOT have LATCH Anchorage Systems. See your vehicle owner's manual if you are unsure if your vehicle is equipped with a LATCH Anchorage System.
- See your vehicle owner's manual for seating positions which are equipped with the LATCH anchorage system.
- For vehicles or vehicle seating positions that do not have a LATCH Anchorage System, install the car seat with a vehicle belt.

## Vehicle Seat Location Requirements



### **WARNING**

- According to crash statistics, children 12 and under are safer when properly restrained in the back seat rather than in the front seat.



- Before using this car seat, reference your vehicle owner's manual for:
  - Car seat installation instructions
  - Information about air bags and car seat use



## WARNING

- DO NOT use this car seat on front seat with an active frontal air bag. Child may be seriously injured or killed when an inflating air bag hits back of child restraint.
- NEVER use this car seat in a front vehicle seat location unless recommended by your vehicle owner's manual.
- Improper placement of this car seat in your vehicle increases the risk of serious injury or death. Some seating positions in your vehicle may not be safe for this car seat. Some vehicles DO NOT have any seating positions that can be used safely with this car seat. If you are not sure where to place this car seat in your vehicle, consult your vehicle owner's manual or call Clek customer service at 1-866-656-2462.



DO NOT place rear-facing child seat on front seat with an active frontal air bag. DEATH OR SERIOUS INJURY can occur. The back seat is safest for children 12 and under.

NE placez PAS un siège pour enfant faisant face à l'avant sur un siège avant équipé d'un airbag frontal actif. LA MORT OU DES BLESSURES GRAVES peuvent survenir. La banquette arrière est la plus sûre pour les enfants de 12 ans et moins.

- Only install this car seat on vehicle seats that face forward. NEVER install this car seat on vehicle seats facing sideways or backwards, as shown in **Figure 32**.
- Only use this car seat on vehicle seats with seat backs that lock in an upright position. Check that the vehicle seat back is locked in an upright position recommended by the vehicle owner's manual for use when installing a child restraint.



**Figure 32**

## Vehicle Belt Requirements

Design and operation of vehicle belt systems vary from vehicle to vehicle and seating position to seating position within a vehicle. Refer to the vehicle owner's manual for information regarding car seat installation and vehicle belt use with a car seat.



### **WARNING**

- NEVER use this car seat with a vehicle belt that is cut, damaged, frayed or inoperable.
- Not all vehicle belts can be used with a car seat. This car seat **MUST** be held tight at all times by the lap belt or lap portion of the lap/shoulder belt.
- Using this car seat with a vehicle belt system unsafe for use with this car seat can result in serious injury or death. Pay careful attention to these systems; some of the vehicle belts that are not safe to use look very much like vehicle belts that are safe to use. If you are unsure, consult your vehicle owner's manual or call Clek Customer Service at 1-866-656-2462.



## WARNING (continued)

- This car seat can not be installed with the Base if installing with an inflatable vehicle belt.
- If installing the car seat without the Base using an inflatable vehicle belt, place lap belt through blue Vehicle Belt Guides and place shoulder belt against vehicle seat back. DO NOT place the shoulder belt around the back of this car seat.

### Vehicle Belt Systems

#### Retractable Lap/Shoulder Belts with a Sliding

**Latchplate:** Shoulder belt is mounted on a retractor (the retractor is not visible), which automatically pulls the shoulder belt back in when released, and latchplate slides freely along the webbing of the vehicle belt, as shown in **Figure 33**.

There are 2 types of retractors: a Switchable Locking Retractor (SLR) or an Emergency Locking Retractor (ELR).

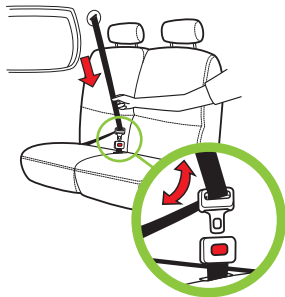

**Figure 33**

To check which type of retractor your lap/shoulder belt is equipped with:

1. Slowly pull the shoulder belt all the way out until it stops.
  2. Allow the shoulder belt to pull back in about 6 in. (15 cm).
  3. Pull out on shoulder belt again:
    - If the belt is locked and will not pull out again, it is equipped with a SLR.
    - If the shoulder belt pulls out again, it is equipped with an Emergency Locking Retractor (ELR).
- If the lap/shoulder belt is equipped with a Switchable Locking Retractor (SLR), it can be used to secure this car seat with or without the Base.
  - If the lap/shoulder belt is equipped with an Emergency Locking Retractor (ELR):
    - It can be used to install this car seat with the Base.
    - It can be used to install this car seat without the Base ONLY if the lap belt stays tightly adjusted around the Carrier when you check for secure installation. If it does not stay tightly secured around the Carrier, then a locking clip may be used to obtain a secure installation. Contact Clek Customer Service to purchase a locking clip.

**NOTE:** Some lap/shoulder belts are equipped with a locking latchplate, which holds the lap portion of the belt at a fixed length when the belt is pulled tight. This type of lap/shoulder belt can be used to secure this car seat with or without the Base.

**Manually Adjustable Lap Belts:** Length can be manually adjusted, as shown in **Figure 34**, and the belt does not retract back into the vehicle.

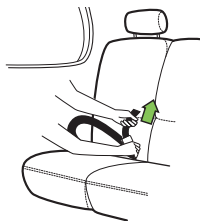

**Figure 34**

- Most manually adjustable lap belts will provide a secure installation of this car seat with or without the Base. If the lap belt loosens, not providing a secure installation, it may be necessary to flip the locking latchplate over 180 degrees to maintain a secure installation as shown in **Figure 35**.



**Figure 35**

**Inflatable Vehicle Belt:** Lap/Shoulder belt with a built-in airbag.

- This car seat may not be compatible with every inflatable lap/shoulder belt. Contact Clek Customer Service at 1-866-656-2462 for more information.
- NEVER install this car seat with the Base if installing with an inflatable vehicle belt. In a seating position with an inflatable belt, the Base must be installed with LATCH or moved to a different seating position.



- If installing the car seat without the Base using an inflatable vehicle belt, place lap belt through blue Vehicle Belt Guides and place shoulder belt against vehicle seat back. **DO NOT** place the shoulder belt around the back of this car seat. Check your vehicle owner's manual for information on how to secure a car seat with the lap portion of the inflatable belt.

**Retractable Lap Belts:** Lap belt is mounted on a retractor which automatically pulls the lap belt back in when released, as shown in **Figure 36**.

There are 3 types of retractors: an Automatic Locking Retractor (ALR), Switchable Locking Retractor (SLR) or an Emergency Locking Retractor (ELR).

To check which type of retractor your retractable lap belt is equipped with:

1. Pull the belt all the way out until it stops.
2. Allow the belt to pull back in about 6 in. (15 cm).
3. Pull out on belt again:
  - If the belt will not pull out again, it is equipped with an ALR or SLR retractor.
  - If the belt pulls out again, it is equipped with an ELR Retractor.

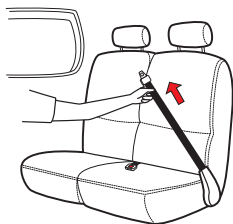

**Figure 36**

### **Retractable Lap Belts (continued):**

If this type of lap belt is equipped with an Automatic Locking Retractor (ALR), or a Switchable Locking Retractor (SLR), it can be used to secure this car seat with or without the Base.

NEVER install this car seat with a lap belt that is equipped with an Emergency Locking Retractor (ELR).

### **Motorized or Door-mounted Vehicle Belts:**

NEVER use a vehicle belt where the shoulder belt is motorized or the lap or shoulder belt is mounted on the vehicle door, as shown in **Figure 37**.

**See your vehicle owner's manual for more information on installing a car seat using the vehicle belt.**

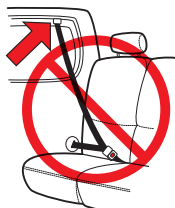

**Figure 37**

## Installing/Removing Car Seat with Base



### **WARNING**

- NEVER use this car seat in the front seat of a vehicle with an active frontal air bag.
- NEVER use this car seat in a front vehicle seat location unless recommended by your vehicle owner's manual.
- To avoid injury this car seat **MUST** be installed by an adult.
- Failure to properly install or use this car seat increases the risk of serious injury or death to the child and others in a sharp turn, sudden stop or crash.
- LATCH Connectors **MUST** be securely attached to the vehicle LATCH anchorages or vehicle belt **MUST** stay tightly adjusted around Car Seat Base at all times when using the Car Seat Base.
- NEVER leave this car seat unsecured in your vehicle. This car seat **MUST** remain secured even when not occupied. In a sharp turn, crash, or sudden stop, an unsecured car seat can be thrown around and could severely injure vehicle occupants.



## **WARNING (continued)**

- Use only in a Rear-Facing position when using this car seat in a vehicle. Serious or crippling injury or death can result if infant faces front of vehicle.
- ALWAYS lift up on Carry Handle after placing Carrier on Car Seat Base to make sure that it is securely attached to the Base.

The Base can be installed using either the LATCH Connectors or the vehicle belt. NEVER install this Base using both the LATCH Connectors and the vehicle belt.

The Base can be installed with or without using the Load Leg. However, the Load Leg is an important safety feature of this car seat and using it is **STRONGLY RECOMMENDED**. If you are unable to install with the Load Leg, it is recommended that you install the Base using the vehicle belt.

## Installing Car Seat Base with LATCH



### WARNING

- Only use the Car Seat Base LATCH system in vehicle seating locations designated by the vehicle manufacturer for use with LATCH and that have a standard anchor spacing of 11 in. (280 mm).
- If your vehicle has a storage compartment under the floor, install Base with Load Leg in that seating position only if approved by the vehicle manufacturer.
- ALWAYS store the Load Leg when not in use.

#### Step 1

Select a forward-facing vehicle seating location which has LATCH, as shown in **Figure 38**. Locate the vehicle LATCH lower anchors as explained in “Vehicle Child Restraint Anchorage System (LATCH)” on **page 41** in this manual and in your vehicle owner’s manual.

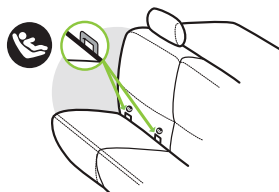

**Figure 38**

## Step 2

Move the front seat of the vehicle all the way forward. This will give you more room to install the Base.

## Step 3

If the vehicle seat back is adjustable, make sure the seat back is locked into an upright position. Refer to vehicle owner's manual for recommended seat back angle. **DO NOT** install or use this car seat while the vehicle seat back is excessively reclined, as shown in **Figure 39**.

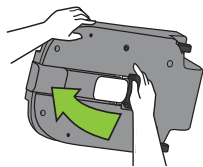

**Figure 39**

## Step 4

Rotate the Load Leg out into the use position by pulling the Load Leg out from the Load Leg Storage on the bottom of the Base, as shown in **Figure 40**.

**IMPORTANT:** Clek **STRONGLY RECOMMENDS** using the Load Leg. However, if you cannot use the Load Leg, Clek recommends installing the Base with a vehicle belt, and not with LATCH. To install the Base with a vehicle belt, go to "Installing Car Seat Base with Vehicle Belt" section on **page 64**.



**Figure 40**

If you cannot use the Load Leg and are installing the Base with LATCH, leave the Load Leg in the Load Leg Storage position and go to the next step.

### Step 5

Extend LATCH Connectors to the fully extended position as shown in **Figure 41**:

- One hand: Press and hold LATCH Adjustment Button (1).
- Other hand: Grasp the end of the LATCH Connector located on the same side of the Base and pull out until it stops (2), and then release LATCH Adjustment Button, to lock into position.
- Repeat on opposite side for other LATCH Connector.

**NOTE:** If LATCH Connectors are not in their fully extended and locked position, they will be free to slide back into the Base during the installation process, and you will not be able to install the Base properly.

### Step 6

Position the Base on the vehicle seat with LATCH Connectors aligned with the vehicle LATCH lower anchors, and with the Load Leg positioned towards the floor, as shown in **Figure 42**.

Push the Base into the back of the vehicle seat until both LATCH connectors lock onto the vehicle LATCH lower anchors, as shown in **Figure 42**.

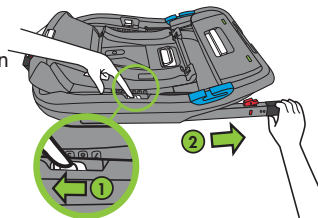

**Figure 41**

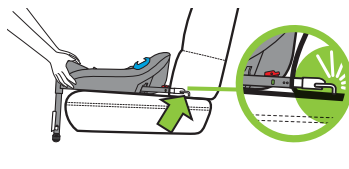

**Figure 42**

## Step 7

Check both LATCH Connector Lock Indicators on the side of the LATCH Connectors to make sure they have changed from solid red (unlocked) to solid green (locked) as shown in **Figure 43**.

Pull forward on the Base to make sure it is securely attached to the vehicle's LATCH lower anchors on both sides. If not, go back to Step 5.

**NOTE:** If LATCH Connectors fail to connect to the vehicle's LATCH lower anchors, you can still use the Base by installing with a vehicle belt. See "Installing Car Seat Base with Vehicle Belt" on **page 64** of this manual.

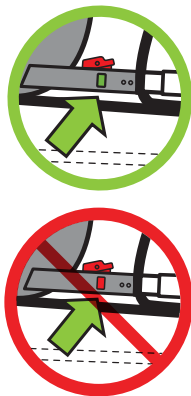

**Figure 43**



## Step 8

Adjust Base to fit snugly against the vehicle seat back:

- Position one hand on each side of the Base.
- Use thumbs to press and hold both LATCH Adjustment Buttons (1) while pushing the Base firmly towards vehicle seat back (2), as shown in **Figure 44**.
- Release LATCH Adjustment Buttons and continue to push the Base toward vehicle seat back until it is in firm contact with the vehicle seat back and locked in position.



Figure 44

## Step 9

Check for secure installation:

- While gripping the Base above the LATCH Connectors, pull Base front to back and left to right to check for secure installation as shown in **Figure 45**. LATCH system **MUST** stay secure and Base should not move more than 1 in. (2.5 cm) in any direction.

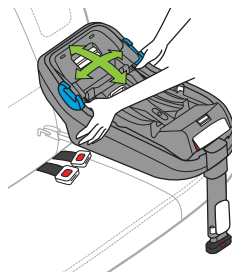

Figure 45

**NOTE:** If LATCH system does not stay securely attached to either of the vehicle lower anchorages or Base cannot be securely installed using LATCH in that seating location, try a different seating location or install using the vehicle belt. See “Installing Car Seat Base With Vehicle Belt” on **page 64** .

**Step 10** (skip to step 11 if not using Load Leg)

Extend Load Leg and lock into position as shown in **Figure 46**:

- Pull out and hold bottom of Load Leg Adjustment Handle (1).
- Grasp Load Leg and pull down to extend Load Leg until it touches the vehicle floor (2).
- Release Adjustment Handle and push down on Load Leg to lock into position.
- Confirm that Load Leg Pressure Indicator has turned from red to green, as shown in **Figure 47**. If Indicator remains red after the Load Leg has been locked into position, extend Load Leg one position further to increase the contact between the vehicle floor and the Load Leg.

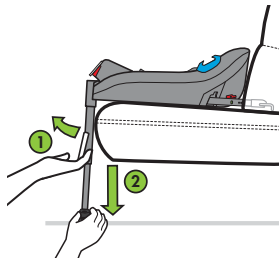

**Figure 46**

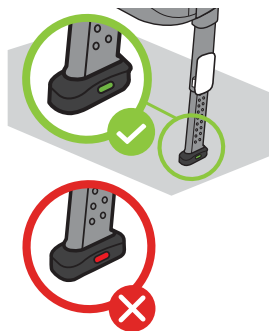

**Figure 47**



## WARNING

- NEVER extend the Load Leg further than needed to turn the Load Leg Indicator from red to green.
- Only use Load Leg when the Indicator is green.

### Step 11

Adjust recline:

- Pull and hold Recline Sled Adjustment Handle and rotate Recline Sled, as shown on **Figure 48**, to the maximum recline adjustment position that keeps part of the bubble within the range specified on the Recline Indicator for the child's weight.

For children over 22 lb (10 kg) who can NOT sit upright unassisted, the bubble must remain in the 11-30 lb (5 - 13.6 kg) range until the child can sit upright unassisted.

Check that Recline Sled is locked into the adjustment position and not between adjustment positions.

**NOTE:** Vehicle **MUST** be parked on level surface when checking or adjusting the recline position.

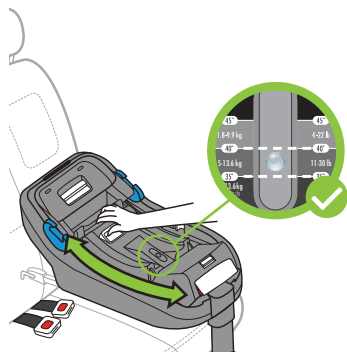

Figure 48

## **WARNING**

- Only use this car seat with the Recline Sled adjusted to the position which places the bubble between the two lines of the Recline Indicator appropriate for the child's weight.
  - A seat too upright could result in an infant's head falling forward, which could restrict the ability to breath.
  - A seat too reclined can increase the risk of injury in a crash.

### Step 12

Secure Carrier onto Base:

- Lower Carrier onto the Base and push down on each side of the Carrier to connect it to the Base as shown in **Figure 49**. The red area on the side of the Release Handle will completely disappear when the Carrier is securely attached. If the red area is visible, the Carrier is NOT properly secured.

Lift up on Carry Handle to ensure Carrier is securely installed on the Base.

**NOTE:** If Carrier will not securely connect to the Base, you may still use this car seat without the Base. See "Installing/Removing Car Seat without Base" on **page 77**.

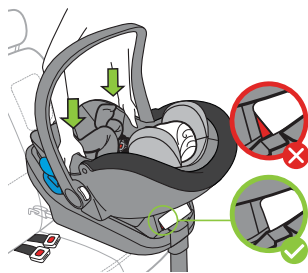

**Figure 49**



## WARNING

- If red indicator on the side of the Release Handle is visible, the Carrier is NOT securely attached to the Base.

### Step 13

Adjust Carry Handle so that it is locked in the upright position.

### Step 14

Adjust the front seat of the vehicle rearward as far back as necessary, but without it touching the back of the Carrier.

## Removing Car Seat Base Installed with LATCH

### Step 1

Adjust Load Leg to shortest position by pulling out and holding bottom of Load Leg Adjustment Handle (1) while pushing up on bottom of Load Leg (2), as shown in **Figure 50**.

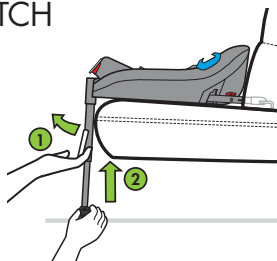
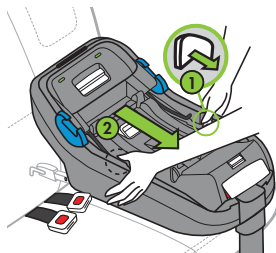

Figure 50

## Step 2

Extend LATCH Connectors by pressing and holding both LATCH Adjustment Buttons (1), and then pulling the Base toward you (2), as shown in **Figure 51**.

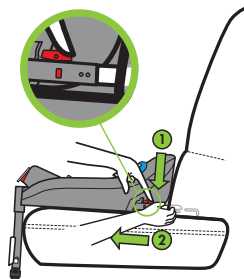

**Figure 51**

## Step 3

Release the LATCH Connector by pressing down (1) and sliding back (2) the red LATCH Release Button, as shown in **Figure 52**. When the Connector releases, the indicators will turn from green (locked) to red (unlocked).

Repeat on opposite side of Base.

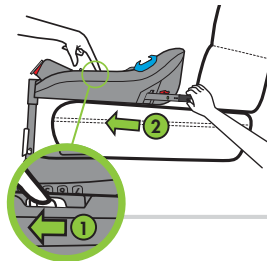

**Figure 52**

#### Step 4

Store LATCH Connectors as shown in **Figure 53**:

- Press and hold LATCH Adjustment Button (1).
- Grasp the end of the LATCH Connector located on the same side of the Base and push to slide Connector back into Base (2).
- Repeat on opposite side for other LATCH Connector.



**Figure 53**

#### Step 5

Store Load Leg:

- Turn Base over and rotate Load Leg into Load Leg Storage on bottom of Base. Press down on Load Leg to lock in place as shown in **Figure 54**.

#### Step 6

Remove Base from vehicle.

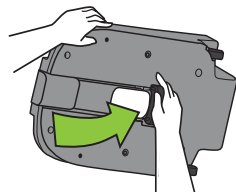

**Figure 54**

## Installing Car Seat Base with Vehicle Belt



### **WARNING**

- Not all vehicle belts are safe for use with this car seat. Read the vehicle belt requirements section in this manual and your vehicle owner's manual.
- Refer to vehicle owner's manual to determine how to secure a child restraint system (car seat) in your vehicle using the vehicle belt.
- Vehicle belt **MUST** stay tightly adjusted around Car Seat Base at all times when installed in a vehicle.
- **NEVER** install this car seat with the Base if installing with an inflatable vehicle belt.
- If your vehicle has a storage compartment under the floor, install car seat with Load Leg in that seating position only if approved by the vehicle manufacturer.
- **ALWAYS** store the Load Leg when not in use.



### Step 1

Select a forward-facing vehicle seating location which has a vehicle belt which can be used with this car seat.

For seating positions with an inflatable vehicle belt, install using LATCH or install without the Base.

### Step 2

Move the front seat of the vehicle all the way forward. This will give you more room to install the Base.

### Step 3

If the vehicle seat back is adjustable, make sure the seat back is locked in a more upright position. **DO NOT** use this car seat while the vehicle seat back is excessively reclined, as shown in **Figure 55**.

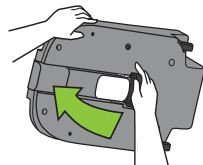

**Figure 55**

#### Step 4

Rotate the Load Leg out into the use position by pulling the Load Leg out from the Load Leg Storage on the bottom of the Base, as shown in **Figure 56**.

**IMPORTANT:** Clek **STRONGLY RECOMMENDS** using the Load Leg. However, if you cannot use the Load Leg, leave the Load Leg in the Load Leg Storage position and go to the next step.



**Figure 56**

#### Step 5

Position Base on the vehicle seat with the Vehicle Belt Guides facing the vehicle seat back and the Load Leg positioned towards the floor, as shown in **Figure 57**.

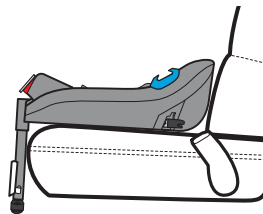
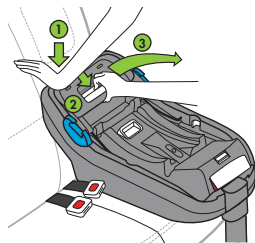

**Figure 57**

## Step 6

Open Belt Tensioner as shown in **Figure 58**:

- One hand: Press down on the front panel of the Belt Tensioner and hold (1).
- Other hand: Squeeze the Belt Tensioner Release Handle to unlock Belt Tensioner (2).
- Rotate Belt Tensioner into the fully open position by rotating toward front of vehicle (3).



**Figure 58**

## Step 7

**If installing with lap/shoulder belt:**

- Route both the lap and shoulder portions of the vehicle lap/shoulder belt through blue Vehicle Belt Guides on each side of Base and buckle vehicle belt as shown in **Figure 59a**.

**NOTE:** DO NOT pull the shoulder belt all the way out to the end. This will put the vehicle belt into locked mode, making the next few steps more difficult.

**If installing with lap-only belt:**

- Route lap-only belt through blue Vehicle Belt Guides on each side of Base and buckle vehicle belt as shown in **Figure 59b**.

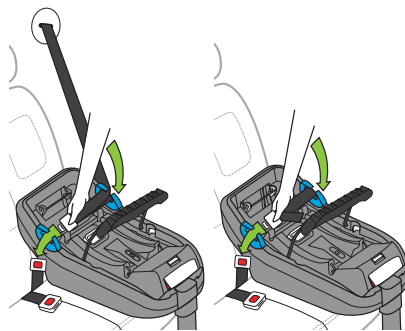

**Figure 59a**

**Figure 59b**

## Step 8

Remove slack from the vehicle belt and close the Belt Tensioner:

### If installing with lap/shoulder belt:

- Remove slack from vehicle belt around Base by pulling the shoulder belt (the top layer of belt on the Base) out to the side and hold, as shown in **Figure 60a**.
- While holding the shoulder belt with one hand, use the other hand to rotate the Belt Tensioner toward the back of the vehicle until it holds the vehicle belt in tension as shown in **Figure 60b**. Use both hands to push down firmly to lock the Belt Tensioner.

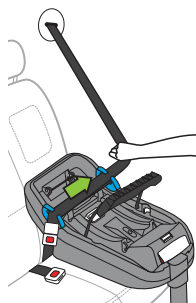

Figure 60a

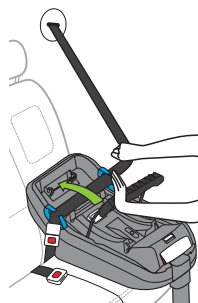

Figure 60b

### If installing with lap-only belt:

- Remove slack from vehicle belt around Base by pulling free end of lap-only belt, as shown in **Figure 61a**.
- Rotate Belt Tensioner toward the back of the vehicle as shown in **Figure 61b**, and use both hands push down firmly to lock the Belt Tensioner.

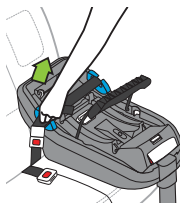

Figure 61a

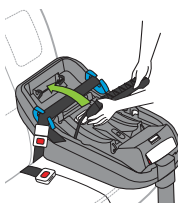

Figure 61b

### Step 9

Confirm that both Belt Tensioner Lock Indicators have changed from Red (unlocked) to Green (locked) as shown in **Figure 62**. If either of the indicators are red, the Belt Tensioner is NOT locked.

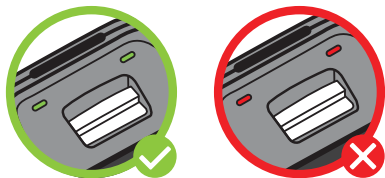

Figure 62



## WARNING

- If either Belt Tensioner Lock Indicator is red, the Belt Tensioner is NOT securely closed. DO NOT use Base if either Belt Tensioner Lock Indicator is not green.

## Step 10

Check for secure installation:

- While gripping the Base near the blue Vehicle Belt Guides, pull front to back and left to right to check for secure installation, as shown in **Figure 63**. Vehicle belt **MUST** stay tightly secured around Base and Base should not move more than 1 in. (2.5 cm) in any direction.

**NOTE:** If vehicle belt does not stay tight or Base cannot be securely installed, try a different vehicle seat location or install using LATCH. See “Installing Car Seat Base with LATCH” on **page 53**.

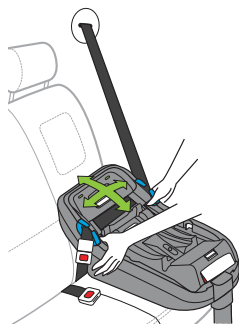
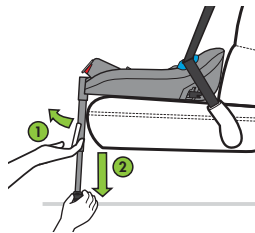

**Figure 63**

## Step 11 (skip to step 12 if not using the Load Leg)

Extend Load Leg and lock into position as shown in **Figure 64**:

- Pull out and hold bottom of Load Leg Adjustment Handle (1).
- Grasp Load Leg and pull down until Load Leg touches the vehicle floor (2).



**Figure 64**

- Release Adjustment Handle and push down on Load Leg to lock into position.
- Confirm that Load Leg Pressure Indicator has turned from red to green, as shown in **Figure 65**. If Indicator remains red after the Load Leg has been locked into position, extend Load Leg one position further to increase the contact between the vehicle floor and the Load Leg.

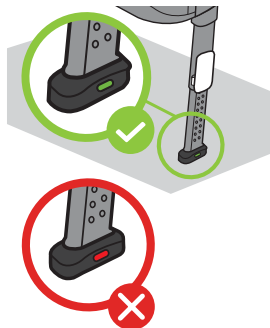

Figure 65



## WARNING

- NEVER extend the Load Leg further than needed to turn the Load Leg Pressure Indicator from red to green.
- Only use Load Leg when the Indicator is green.

## Step 12

Adjust recline:

- Pull and hold Recline Sled Adjustment Handle, as shown in **Figure 66**, and rotate Recline Sled to the maximum recline adjustment position that keeps part of the bubble within the range specified on the Recline Indicator for the child's weight.

For children over 22 lb (10 kg) who can NOT sit upright unassisted, the bubble must remain in the 11-30 lb (5-13.6 kg) range until the child can sit upright unassisted.

Check that Recline Sled is locked into the adjustment position and not between adjustment positions.

**NOTE:** Vehicle MUST be parked on level surface when checking or adjusting the recline position.

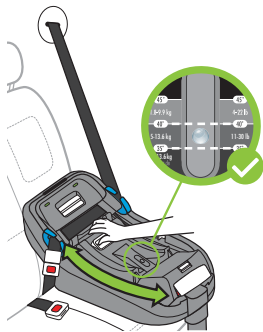

**Figure 66**



## WARNING

- Only use this car seat with the Recline Sled adjusted to the position which places the bubble between the two lines on the Recline Indicator appropriate for the child's weight.
  - A seat too upright could result in an infant's head falling forward, which could restrict the ability to breath.
  - A seat too reclined can increase the risk of injury in a crash.



### Step 13

Secure Carrier onto Base:

- Lower Carrier onto Base and push down on each side of the Carrier to connect it to the Base as shown in **Figure 67**. The red area on the side of the Release Handle will completely disappear when the Carrier is securely attached. If the red area is visible, the Carrier is NOT properly secured.

Lift up on Carry Handle to ensure Carrier is securely installed on the Base.

**NOTE:** If Carrier will not securely connect to the Base, you may still use this car seat without the Base. See “Installing/Removing Car Seat without Base” on **page 77**.

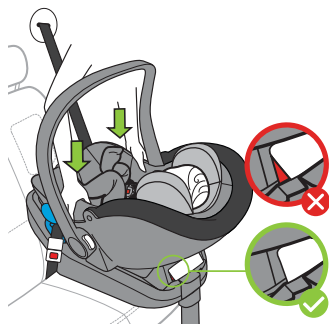

Figure 67



## WARNING

- If the red indicator is visible on the Release Handle, the Carrier is NOT securely attached to the Base.

### Step 14

Adjust Carry Handle position so that it is locked in the upright position.

### Step 15

Adjust front seat of the vehicle rearward as far back as necessary, but without it touching the back of the Carrier.

## Removing Car Seat Base Installed with Vehicle Belt

### Step 1

Adjust Load Leg to shortest position by pulling out and holding bottom of Load Leg Adjustment Handle (1) while pushing up on bottom of Load Leg (2), as shown in **Figure 68**.

### Step 2

Unbuckle vehicle belt.

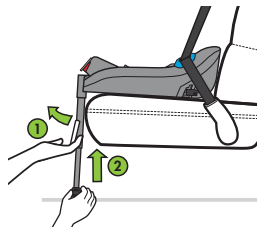
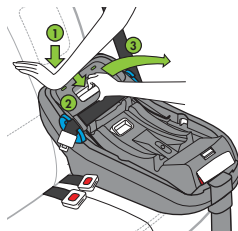

**Figure 68**

### Step 3

Open Belt Tensioner as shown in **Figure 69**:

- One hand: Press down on the front panel of the Belt Tensioner and hold (1).
- Other hand: Squeeze the Belt Tensioner Release Handle to unlock Belt Tensioner (2).
- Rotate Belt Tensioner into the fully open position by rotating toward front of vehicle (3).



**Figure 69**

### Step 4

Remove vehicle belt from blue Vehicle Belt Guides, as shown in **Figure 70**.

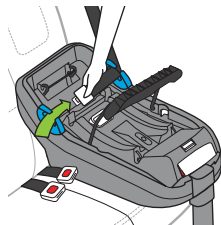

**Figure 70**

### Step 5

Rotate Belt Tensioner toward the vehicle seat and push down to lock closed, as shown in **Figure 71**.

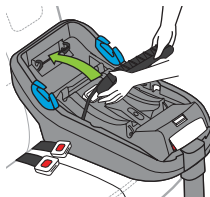

**Figure 71**

### Step 6

Turn Base over and rotate Load Leg into Load Leg Storage on bottom of Base. Press down on Load Leg to lock in place as shown in **Figure 72**.

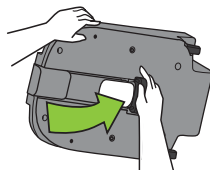

**Figure 72**

### Step 7

Remove Base from vehicle.

## Installing/Removing Car Seat without Base



### **WARNING**

- NEVER use this car seat in the front seat of a vehicle with an active frontal air bag.
- NEVER use this car seat in a front vehicle seat location unless recommended by your vehicle owner's manual.
- To avoid injury this car seat **MUST** be installed by an adult.
- Failure to properly install or use this car seat increases the risk of serious injury or death to the child and others in a sharp turn, sudden stop or crash.
- NEVER leave this car seat unsecured in your vehicle. This car seat **MUST** remain secured even when not occupied. In a sharp turn, crash, or sudden stop, an unsecured car seat can be thrown around and could severely injure vehicle occupants.



## **WARNING** (continued)

- Use only in a Rear-Facing position when using this car seat in a vehicle. Serious or crippling injury or death can result if infant faces front of vehicle.
- If installing the car seat without the Base using an inflatable vehicle belt, place lap belt through blue Vehicle Belt Guides and place shoulder belt against vehicle seat back. **DO NOT** place the shoulder belt around the back of Carrier.
- Not all vehicle belts are safe for use with this car seat. Read the vehicle belt requirements section in this manual and your vehicle owner's manual.
- Refer to vehicle owner's manual to determine how to secure a child restraint system (car seat) in your vehicle using the vehicle belt.
- Vehicle belt **MUST** stay tightly adjusted around Carrier at all times when installed in a vehicle.
- When installing the Carrier in a vehicle, the Carrier **MUST** be installed with a vehicle lap or lap/shoulder belt.

## Installing Car Seat without Base with Vehicle Belt

### Step 1

Secure child in Carrier. See “Securing Your Child in Car Seat” on **page 29**.

### Step 2

Select a forward-facing vehicle seating location which has a vehicle belt which can be used with this car seat.

### Step 3

If the vehicle seat back is adjustable, make sure the seat back is locked in a more upright position. Refer to vehicle owner’s manual for recommended seat back angle. **DO NOT** install or use this car seat while the vehicle seat back is excessively reclined, as shown in **Figure 73**.

### Step 4

Move the front seat of the vehicle all the way forward. This will give you more room to install the Carrier.

### Step 5

Adjust or confirm that the Carry Handle is locked in upright position. To adjust Carry Handle: press both Carry Handle Adjustment Buttons and rotate Handle until it locks in the upright position as shown in **Figure 74**.



**Figure 73**

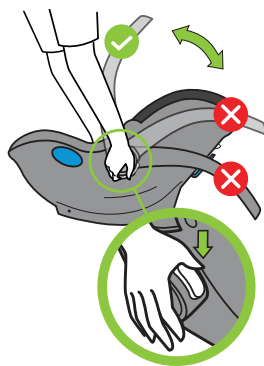

**Figure 74**

## Step 6

Position Carrier on vehicle seat with child facing the rear of the vehicle, and rotate Carrier so that the blue Recline Reference Line on side of Carrier is parallel with the ground, as shown in **Figure 75**.

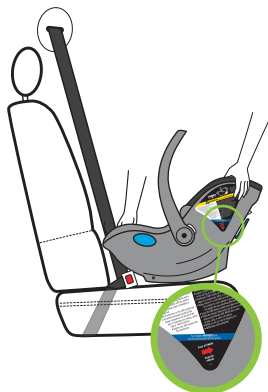

**Figure 75**

## **WARNING**

- When installing, **ALWAYS** position Carrier so that blue Recline Reference Line on side of Carrier is parallel with the ground.
  - A seat too upright could result in an infant's head falling forward, which could restrict the ability to breathe.
  - A seat too reclined can increase the risk of injury in a crash.



## Step 7

### If installing with lap/shoulder belt:

- Route lap portion of the vehicle belt through both blue Vehicle Lap Belt Guides (1) and buckle vehicle belt as shown in **Figure 76a**. DO NOT pull the vehicle belt all the way out during this step.

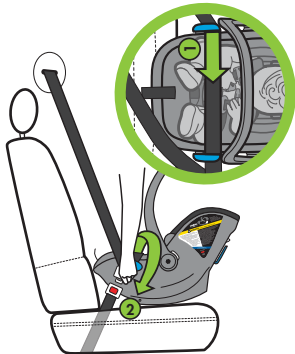

Figure 76a

### If installing with lap-only belt:

- Route the lap belt through both blue Vehicle Lap Belt Guides and buckle vehicle belt as shown in **Figure 76b**.

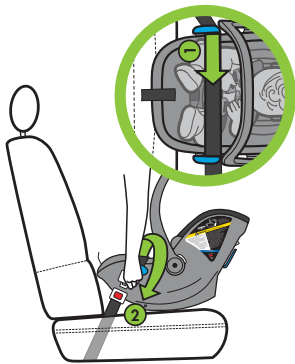

Figure 76b

## Step 8

If installing with a lap/shoulder belt follow the instructions for a lap/shoulder belt or inflatable shoulder belt in this section. If installing with a lap-only belt, skip to **Step 9**.

### If installing with lap/shoulder belt:

- Slowly pull the vehicle shoulder belt all the way out to its full length, and hold.
- With one hand firmly holding the shoulder belt so it doesn't retract, wrap the shoulder belt around the back of the Carrier with the other hand, and tuck the shoulder belt into the blue Shoulder Belt Guide, as shown in **Figure 77**.

**NOTE:** If the vehicle shoulder belt is too short to wrap around the back of the Carrier, unbuckle the vehicle belt, remove the lap portion of the belt from the blue Vehicle Lap Belt Guides and allow the vehicle belt to fully retract. Then repeat **Step 7**, and do the following as an alternative to **Step 8**:

- Slowly pull the vehicle shoulder belt all the way out to its full length, and hold. Take care to keep it fully extended.
- Use other hand to shift Carrier more upright so that vehicle shoulder belt is able to wrap around the back of Carrier and tuck the shoulder belt into the blue Shoulder Belt Guide.
- Gently shift Carrier so that blue Recline Reference Line is parallel to the ground.

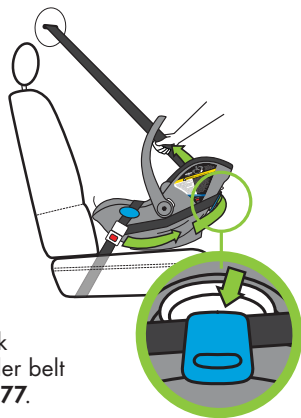

**Figure 77**

If you are still unable to shift Carrier so that blue Reference Line is parallel to the ground, remove the vehicle shoulder belt from around the back of the Carrier and let it retract into a position against the front of the vehicle seat back as shown in **Figure 78** and shift the Carrier so that the blue Reference Line is parallel to the ground, or move to another seating position.

#### If installing with an inflatable vehicle belt:

- DO NOT wrap shoulder belt around back of Carrier. Let the shoulder belt retract into a position against the front of the vehicle seat back as shown in **Figure 78**.

#### Step 9

Tighten Vehicle Belt to secure the Carrier.

#### If installing with lap/shoulder belt:

- Use your body to push and wiggle the Carrier into the vehicle seat back while pulling shoulder belt to remove all slack, as shown in **Figure 79**.

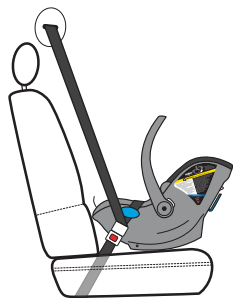

**Figure 78**

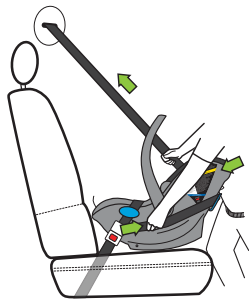

**Figure 79**

### If installing with lap-only belt:

- Use your body to push and wiggle the Carrier into the vehicle seat back and pull free end of lap-only belt to remove all slack as shown in **Figure 80**.

### If installing with an inflatable belt:

- Switch the lap portion of the lap/shoulder belt to the automatic locking mode by pulling the lap portion of the lap/shoulder belt all the way out as shown in your vehicle manual.
- Use your body to push and wiggle the Carrier into the vehicle seat back and pull down on the lap portion of inflatable vehicle belt to tighten as shown in **Figure 81**.

**NOTE:** The lap portion of the inflatable vehicle belt **MUST** remain tight and not lengthen when pressure is released from the seat. If the lap portion of the inflatable vehicle belt does not remain tight, repeat this step and refer to your vehicle manual.



**Figure 80**

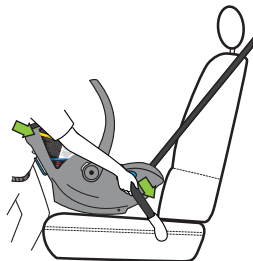

**Figure 81**

## Step 10

Check for secure installation:

- Grip Carrier near blue Vehicle Lap Belt Guides and pull Carrier side-to-side and front-to-back to check for secure installation, as shown in **Figure 82**. The Carrier should not move more than 1 in. (2.5 cm) at the belt path. Do not push down on Carrier near the child's feet when checking for movement.

**NOTE:** If vehicle belt does not stay tight or Carrier cannot be securely installed, try a different vehicle seating location or install car seat using Car Seat Base. See "Installing/Removing Car Seat with Base" on **page 51**.

## Step 11

Verify that the blue Recline Reference Line on side of seat is parallel with ground, as shown in **Figure 83**. If not, go back to **Step 6**, adjust the recline of the Carrier, and install again – being careful during **Step 9** to push the Carrier straight into the back of the vehicle seat without tilting it more upright, or move the Carrier to a different vehicle seating position.

**NOTE:** If needed, a rolled towel or pool noodle may be placed under the foot end of the Carrier to achieve an acceptable recline level.

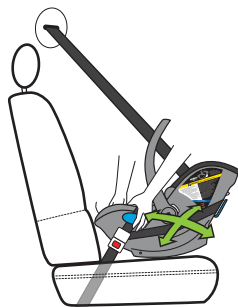

**Figure 82**



**Figure 83**

## Removing Car Seat without Base Installed with Vehicle Belt

### Step 1

#### **If installed with lap-only belt:**

- Unbuckle vehicle belt.

#### **If installed with lap/shoulder belt:**

- With one hand: Hold the shoulder belt so it doesn't get shorter.
- With the other hand: Unbuckle vehicle belt, remove the shoulder belt from the blue Shoulder Belt Guide, and move the shoulder belt over and off of Carrier.

### Step 2

Remove the lap belt from the blue Vehicle Lap Belt Guides.

### Step 3

Remove Carrier from vehicle.

## Using Carrier Outside of the Vehicle

Thousands of children are injured or die every year in their car seat when used outside of the vehicle as a result of suffocation, falling and/or strangulation.

Carefully review these warnings. Failure to follow these warnings can result in serious injury or death of the child.



### WARNING

- Strangulation Hazard: Children have **STRANGLERD** in loose or partially buckled Harness Straps. Fully restrain your child even when Carrier is used outside the vehicle.
- Strangulation Hazard: **NEVER** buckle just the Chest Clip. If the Chest Clip is closed and the Harness is not properly buckled, children can strangle on the Chest Clip.
- Fall Hazard: Child's activity can move Carrier. **NEVER** place Carrier on counter tops, tables, or any other elevated surface.

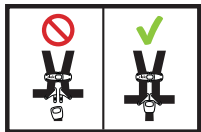



## **WARNING** (continued)

- Suffocation Hazard: Carrier can roll over on soft surfaces and suffocate child. NEVER place Carrier on beds, sofas, or other soft surfaces.
- NEVER leave child unattended. ALWAYS keep infant in view even when napping. DO NOT allow infant to sleep unattended in this car seat.
- Fall Hazard: NEVER place this Carrier on a shopping cart. Carrier may be placed inside large basket of shopping cart (where it can't fall), or securely attached to a compatible stroller.

### Using Carrier on Stroller

This Carrier may be used on most strollers that have Maxi-Cosi® car seat adapters. Only use Carrier with strollers or stroller car seat adapters that are approved for use with this car seat. For a complete list of approved strollers and stroller car seat adapters, please visit: [www.clekinc.com/support/liing](http://www.clekinc.com/support/liing)

Carefully review and follow all information and instructions in your stroller manual that are specific to car seat or carrier use with the stroller.

Maxi-Cosi is a registered trademark of Dorel Juvenile Group, Inc.





## WARNING

- ALWAYS lift up on Carry Handle after placing Carrier on stroller to make sure that it is securely attached to the stroller.
- DO NOT use Carrier on the stroller if the Carrier does not securely lock onto the adapter on both sides of the stroller. If the Carrier does not securely lock onto the adapters, the Carrier could fall off the stroller resulting in serious injury to the child.

### Installing Carrier on Stroller

#### Step 1

Set the parking brake on the stroller.

#### Step 2

Securely attach the car seat adapters to the stroller by following the stroller manufacturer's instructions.

Check that car seat adapters are securely attached to the stroller.

### Step 3

**IMPORTANT:** The Carrier must be installed with the child facing the stroller handle. NEVER install the Carrier with the child facing away from the stroller handle.

Securely attach the Carrier onto the car seat adapters:

- With the child properly secured in the Carrier position the Carrier so that the Stroller Attachment Points on the Carrier are positioned directly above the stroller car seat adapters, and lower Carrier onto the adapters, as shown in **Figure 84**.

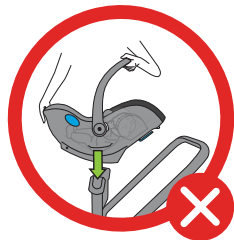

**Figure 84**

- Push down on each side of the Carrier to lock onto each adapter, as shown in **Figure 85**.

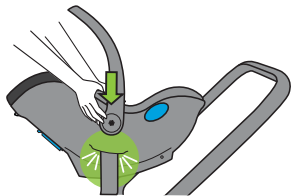

**Figure 85**

#### Step 4

Pull up on the Carrier to ensure that it is securely locked on both sides of the stroller, as shown in **Figure 86**.

**NOTE:** It can be helpful to put the Carrier on the adapters one side at a time, and after lowering the Carrier onto the 1st adapter, push the 2nd adapter towards the Carrier while lowering the Carrier onto the 2nd adapter.

Check for these steps:

- ✓ Lift up on Carrier to ensure that it is securely locked on the stroller on each side.
- ✓ Carrier is installed in the orientation that has the child facing the stroller handle.

#### Step 5

Make any necessary adjustments to the stroller handle position

**IMPORTANT:** Certain strollers have handle positions that cannot be used with this Carrier. Please visit: [www.clekinc.com/support/liing](http://www.clekinc.com/support/liing) for a list of any restrictions.

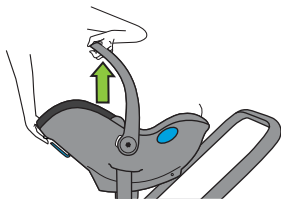

**Figure 86**

## Releasing Carrier from Stroller

Confirm that the Carry Handle is locked in the upright position.

Squeeze the Stroller Release Handle on the back of the Carrier as shown in **Figure 87**, and lift the Carrier off of the stroller.

**NOTE:** If the Carrier feels stuck, it can be helpful to squeeze the Stroller Release Handle while pushing down on the Carrier on the side that feels stuck. Then, while still squeezing the Stroller Release Handle, lift the Carrier off the stroller.

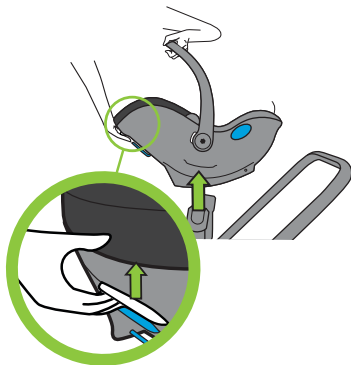

**Figure 87**

# Aircraft Installation

Clek strongly recommends that children are secured in a car seat during airline travel.

This car seat may only be installed on an aircraft without the Car Seat Base. To install this car seat without the Base, follow the instructions for installing with a lap-only belt in “Installing/Removing Car Seat without Base” on **page 77**.

**NOTE:** NEVER install this car seat on aircraft using the Base.

# Care and Cleaning

Carrier Cover, Headrest and Newborn Support Cushion may be spot cleaned or hand washed. If a thorough cleaning is necessary, see “Removing/Installing Carrier Cover” on **page 96**, and “Newborn Support Cushion Removal/Installation” on **page 27**. Follow the hand washing instructions on **page 95**.

## Car Seat Cleaning

### FABRIC CARE INSTRUCTIONS

#### Spot Cleaning:

##### Step 1

If the spot has dried, try lightly brushing or scraping off the residue. Wipe surface with water.

##### Step 2

If a spot still remains, apply a solution of mild detergent and water to fabric with a light mist.

##### Step 3

Work area using soft brush or edge of spoon from outside of spot towards the middle.

##### Step 4

Allow solution to work for approximately one minute.

##### Step 5

Remove with clean water or blot with clean soft towel.

### **Step 6**

Repeat steps 3-5 as necessary until spot is removed.

### **Step 7**

Rinse with clear lukewarm water and blot with clean soft white cloth as final step.

### **Hand Washing:**

Remove Cover as described on **page 96** and hand wash in solution of mild detergent and water, no bleach or fabric softener. Rinse in clear water and hang to dry. **DO NOT** place in dryer. Carrier Cover and Newborn Support Cushion may be washed in washing machine on gentle cycle and hung to dry. **NEVER** wash Headrest in washing machine.

### **EXTERIOR PLASTICS ONLY WASHING INSTRUCTIONS**

Use a soft cloth with warm water and mild soap. Apply light pressure with cloth in small circular motions.

**DO NOT** remove the labels from this car seat. They are meant to be permanent so they can remind you and others of important information. Removal will marr the finish of the seat.

### **HARNESS CARE INSTRUCTIONS**

Surface wash Shoulder Harness Straps and Harness Adjuster Strap with a damp cloth using warm water and a mild detergent.

Rinse with clear lukewarm water and blot with clean soft cloth as final step.

### **BUCKLE WASHING INSTRUCTIONS**

Buckle may be rinsed under warm water. **DO NOT** use detergents or lubricants.

## Removing/Installing Carrier Cover

### PREPARE TO REMOVE CARRIER COVER (All Models)

#### Step 1

Ensure that Canopy is in the closed position.

Adjust Carry Handle to the ground position by pressing both Carry Handle Adjustment Buttons and rotating the Carry Handle until it locks into Position 3, as showing in **Figure 88**.

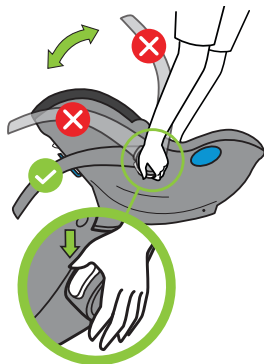

Figure 88

#### Step 2

Loosen Harness by pressing down on the Harness Adjuster Tab and pulling out on Shoulder Harness Straps, as shown in **Figure 89**.

**NOTE:** Check which Shoulder Harness Slots the Shoulder Harness Straps are routed through, so they can be rethreaded through the same Slots when rethreading.

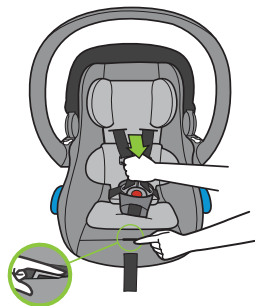

Figure 89



### Step 3

Turn Carrier over and remove loop at end of each Shoulder Harness Strap from Metal Harness Plate by sliding Strap out through slot in Metal Harness Plate as shown in **Figure 90**.

From front of Carrier, pull Shoulder Harness Straps out of Carrier Seat Back and Headrest. Set Headrest to the side. (If present) Remove the Newborn Support Cushion. See “Newborn Support Cushion Removal/Installation” on **page 27**.

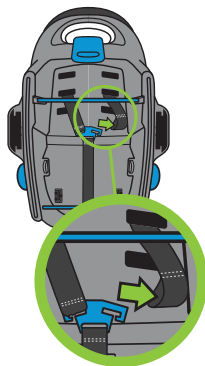

Figure 90

### TO REMOVE CARRIER COVER (Models Without Zipper)

#### Step 1

Turn Carrier over and locate Inner Shell Release Tabs. Press each Inner Shell Release Tab away from the center of the Carrier, as shown in **Figure 91** and press down.

**NOTE:** It may be easier to place Carrier on its side and release Shell Release Tab that is on top (with one hand), while pulling Inner Shell away from Outer Shell (with the other hand). Then, flip the Carrier over to the opposite side and repeat.

#### Step 2

Turn Carrier on side and pull Inner Carrier Shell away from Outer Carrier Shell.

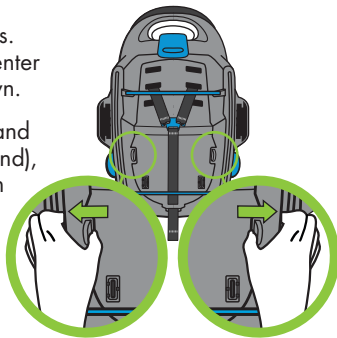
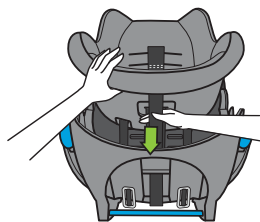

Figure 91

### Step 3

Pull Harness Adjuster Strap out of Inner Carrier Shell as shown in **Figure 92**.

DO NOT remove Harness Adjuster Strap from Outer Carrier Shell.



**Figure 92**

### Step 4

Remove Crotch Strap and Buckle from Buckle Pad by pressing down on top of Buckle to push it down and out of Buckle Pad as shown in **Figure 93**.

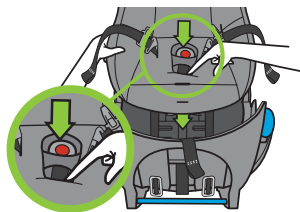

**Figure 93**

Lift Inner Carrier Shell with one hand and use other hand to pull Buckle and Crotch Strap out of Inner Carrier Shell as shown in **Figure 94**.

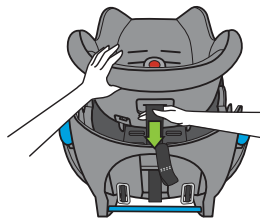

**Figure 94**

## Step 5

Remove Shoulder Harness Straps from Inner Carrier Shell.

For each Shoulder Harness Strap:

- Push Buckle Tongue down through hip strap opening in Carrier Cover and Inner Carrier Shell, as shown in **Figure 95**.

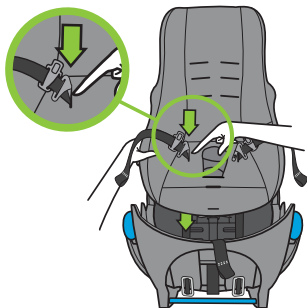

**Figure 95**

- Position Chest Clip so that end of Chest Clip is aligned with the hip strap opening, and push Chest Clip down through hip strap opening in Carrier Cover and Inner Carrier Shell, as shown in **Figure 96**.
- Position hand between Inner and Outer Carrier Shell and pull remaining Shoulder Harness Strap length down through the hip strap opening.

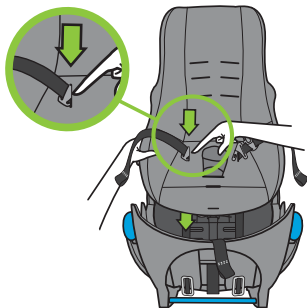

**Figure 96**

## Step 6

Remove Carrier Cover:

- Release bottom edge of Carrier Cover from Inner Carrier Shell by sliding Cover up and over the bottom edge.

- Unfasten side tab on each side by sliding tabs down and out from under the edge of the Inner Shell, as shown in **Figure 97**.
- Pull up on top of Carrier Cover to complete removal of Carrier Cover.

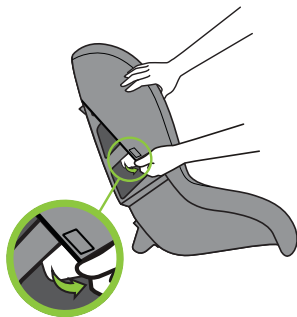
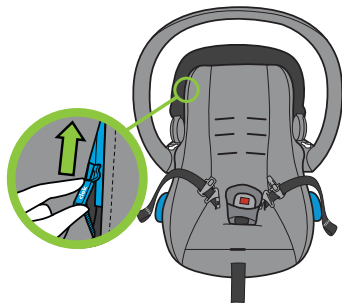

**Figure 97**

## **TO REMOVE CARRIER COVER (Models With Zipper)**

### **Step 1**

Unzip Carrier Cover by grasping zipper pull tab as shown in **Figure 98** and pulling until fully unzipped.



**Figure 98**

## Step 2

Remove Crotch Strap and Buckle from Buckle Pad by pressing down on top of Buckle to push it down and out of Buckle Pad as shown in **Figure 99**.

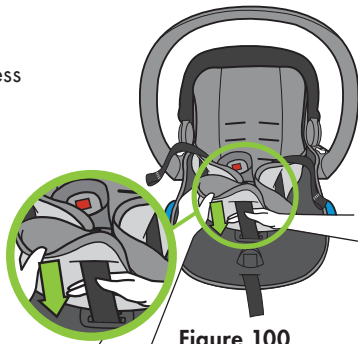

**Figure 99**

## Step 3

Lift bottom of Carrier Cover up and remove Harness Adjuster Strap and Crotch Strap, and Shoulder Harness Straps from Carrier Cover as shown in **Figure 100**.

**NOTE:** For each Shoulder Harness Strap push Buckle Tongue and end of Chest Clip through the hip strap opening in the Carrier Cover.



**Figure 100**

## TO INSTALL CARRIER COVER (Models With Zipper)

### Step 1

Route each Shoulder Harness Strap through Carrier Cover as shown in **Figure 101**.

For each Shoulder Harness Strap:

- Push end of Shoulder Harness Strap up through hip strap opening in cover. Take care that Harness Strap remains flat and untwisted.
- Position end of Chest Clip at hip strap opening and push up through opening.
- Push Buckle Tongue up through hip strap opening.

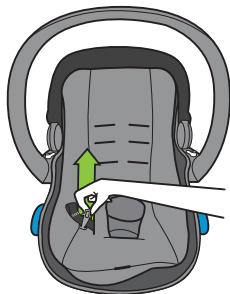

Figure 101

### Step 2

Push Crotch Strap up through opening in Carrier Cover (1) and route Adjuster Strap through front slot in Carrier Cover (2) as shown in **Figure 102**.

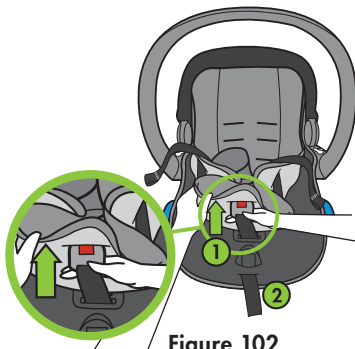
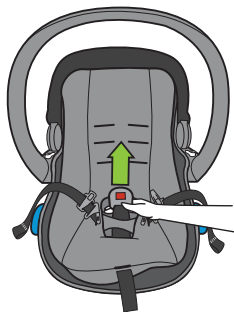

Figure 102

### Step 3

Pull buckle through Buckle Pad as shown in **Figure 103**.

**IMPORTANT:** Check that Shoulder Harness Straps, Crotch Strap, and Adjuster Strap are flat, with no twists, and pulled all the way through Carrier Cover by buckling Harness and Chest Clip before moving to **Step 4**.



**Figure 103**

### Step 4

Slide Carrier Cover zipper end into the receiving zipper end on the carrier shell as shown in **Figure 104**, then grasp zipper tab and fully close the zipper.



**Figure 104**

### Step 5

Rethread the Shoulder Harness Straps. See “Changing Shoulder Harness Height” on **page 20**.

## TO INSTALL CARRIER COVER (Models Without Zipper)

### Step 1

Position Carrier Cover above Inner Carrier Shell and slide top of Carrier Cover over top edge of Inner Carrier Shell.

Smooth Carrier Cover down into the seat until the bottom contacts the bottom of the Inner Carrier Shell, then pull bottom elastic edge of the Carrier Cover down and over the bottom edge to secure it around bottom edge of Inner Carrier Shell.

Attach side tab on each side of Carrier Cover by tucking tab under edge of Inner Carrier Shell, as shown in **Figure 105**.

Check that Carrier Cover is in position with the Shoulder Harness Slot openings aligned between the Carrier Cover and the Inner Carrier Shell.

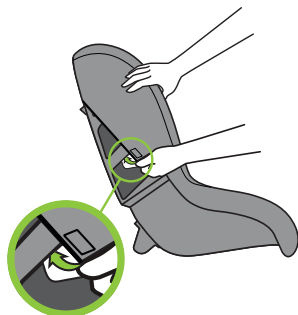

**Figure 105**



## Step 2

Position Inner Carrier Shell above Outer Carrier Shell and route Shoulder Harness Straps up through hip strap opening in Inner Carrier Shell and Carrier Cover as shown in **Figure 106**.

For each Shoulder Harness Strap:

- Push end of Shoulder Harness Strap up through hip strap opening in inner shell and cover. Make sure that the Shoulder Harness Straps remain untwisted when routing through the hip strap openings.
- Position end of Chest Clip at hip strap opening and push up through opening.
- Push Buckle Tongue up through hip strap openings.
- Repeat for other Shoulder Harness Strap.

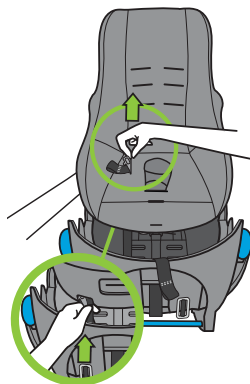
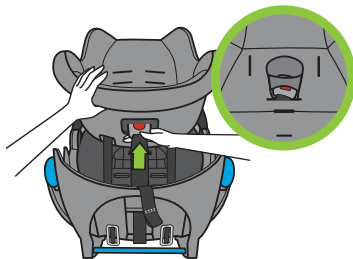

**Figure 106**

## Step 3

Push Crotch Strap up through the opening in the Inner Carrier Shell and Cover, as shown in **Figure 107**.

From top of Cover, pull Buckle all the way up, taking care that there are no twists in the Crotch Strap, then insert Buckle through Buckle Pad.



**Figure 107**

#### Step 4

Re-thread Harness Adjuster Strap up through slot in Inner Carrier Shell and Cover as shown in **Figure 108**.

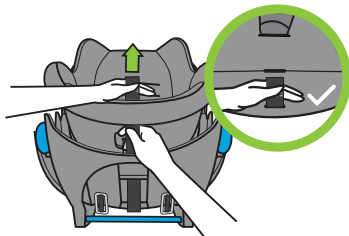

**Figure 108**

#### Step 5

Check that entire length of Shoulder Harness Straps and Crotch Strap are pulled to top side of Inner Carrier Shell and Cover, and that straps are free of twists.

#### Step 6

Align Inner Carrier Shell over Outer Carrier Shell so that each side of Inner Carrier Shell overlaps the raised ridge on Outer Carrier Shell and lower Inner Shell down into Outer Shell, as shown **Figure 109**.

From top of seat, press firmly down on Inner Carrier Shell until it locks onto Outer Carrier Shell.

Lift up on each side to check that the Inner Carrier Shell is locked into the Outer Carrier Shell.

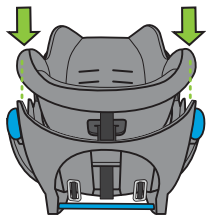

**Figure 109**

Turn Carrier over and confirm that both Inner Shell Release Tabs are through Outer Carrier Shell and locked in position, as shown in **Figure 110**.

**NOTE:** You may need to pull the Canopy fabric out of the way so that it falls over the Inner Shell and does not get trapped between the Inner and Outer Shells.

**NOTE:** If Inner Carrier Shell does not lock into Outer Carrier Shell, confirm that Shoulder Harness Straps and Crotch Strap are pulled to top side of Inner Carrier Shell. Contact Clek Customer Service at 1-866-656-2462 if unable to lock the Inner Carrier Shell in place.



**Figure 110**

Check for this step:

- ✓ Straps are flat and not twisted.
- ✓ Inner Shell Release Tabs are through Outer Carrier Shell and locked in position.

### **Step 7**

Buckle Harness.

### **Step 8**

Rethread the Shoulder Harness Straps. See “Changing Shoulder Harness Height” on **page 20**.

## RECYCLING YOUR CAR SEAT

For instructions on how to recycle your Clek Liing infant seat, please visit:  
[www.clekinc.com/support-articles/how-do-i-recycle-my-seat](http://www.clekinc.com/support-articles/how-do-i-recycle-my-seat)

## Troubleshooting

For instructions on troubleshooting your Clek Liing infant seat, please visit:  
[www.clekinc.com/support/liing](http://www.clekinc.com/support/liing)

## Accessories

Optional accessories for this product may be purchased at:  
[www.clekinc.com/accessories](http://www.clekinc.com/accessories)

# Warranty

## LIMITED WARRANTY

Clek Inc. warrants, only to the original consumer purchaser and only if this product was purchased (new and unused in an unopened box) from an authorized Clek retailer listed at [www.clekinc.com](http://www.clekinc.com), that this product will be free from defects in material and workmanship for one (1) year from the date of original purchase (the “Warranty Period”). During the Warranty Period, Clek Inc. will, at its option, repair or replace this product if it is found by the manufacturer to be defective in material or workmanship. Clek Inc. reserves the right to discontinue or change parts, fabrics, models, or products, or to substitute this product with a comparable model or product. To make a claim under this warranty, please contact us at <https://clekinc.com/support/contact-us/>, call us at 1-866-656-2462, or write to us at Clek Inc., Attn: Customer Service, Clek Inc., 226 Lesmill Road, Toronto, ON, Canada M3B 2T5. An original receipt is required to validate your warranty and shipping charges will be the responsibility of the original consumer purchaser. To expedite the processing of any future warranty claims and to verify the original date of purchase, please complete and mail the pre-addressed owner registration card within thirty (30) days of purchase.

## **WARRANTY LIMITATIONS**

This warranty does not cover the effects of normal wear and tear or damage resulting from negligence, modification, improper installation, accidents, misuse or abuse of this product. It is expressly agreed that the obligations of Clek Inc. and the original consumer purchaser's remedies under the limited warranty contained herein are exclusive and are strictly limited to the repair or replacement of the product. This limited warranty is conditional upon strict compliance with the provisions of the Instruction Manual. In no event will Clek Inc. or the dealer selling this product be liable to you for any damages, including incidental or consequential damages, arising out of the use or inability to use this product.

## **LIMITATION OF WARRANTIES AND STATE/PROVINCIAL LAW RIGHTS**

The warranty and remedies as set forth above are exclusive and in lieu of all others, oral or written, express or implied. To the extent permitted by applicable law, any implied warranties, including implied warranties of merchantability and fitness for a particular purpose, are hereby disclaimed. Some states/provinces DO NOT allow limitations as to how long an implied warranty lasts or the exclusion or limitation of incidental or consequential damages, so the above limitations may not apply to you. This warranty gives you specific legal rights, and you may have other rights, which vary from state/province to state/province. Neither Clek Inc. nor the dealer selling this product has authorized any person to create for it any other warranty, obligation, or liability in connection with this product.

## How To Receive Spanish Instructions

This instruction manual is also available in Spanish. To request a copy to be sent to you free of charge, please contact Clek Customer Service at 1-866-656-2462 or email us at [customerservice@clekinc.com](mailto:customerservice@clekinc.com). You can also download a copy of the Liing instruction manual in Spanish online at:

[www.clekinc.com/support/liing/videos-and-manuals](http://www.clekinc.com/support/liing/videos-and-manuals)

## Cómo recibir las instrucciones en español

Este manual de instrucciones también está disponible en español. Para pedir que se le envíe una copia sin cargo alguno, tenga a bien ponerse en contacto con el servicio al cliente de Clek, para lo cual llame al 1-866-656-2462 o envíe un mensaje de correo electrónico a [customerservice@clekinc.com](mailto:customerservice@clekinc.com). También puede descargar una copia del manual de instrucciones de Liing en español por Internet en

[www.clekinc.com/support/liing/videos-and-manuals](http://www.clekinc.com/support/liing/videos-and-manuals)

Keep this Instruction Manual for future use.  
Store in the Instruction Manual Storage Slot in Car Seat Base.



[www.clekinc.com](http://www.clekinc.com)

Clek Inc.  
226 Lesmill Road  
Toronto, Ontario Canada  
M3B 2T5  
1-866-656-2462