



FO24USG1



Foonf Instruction Manual

This car seat is designed for use either Rear-Facing or Forward-Facing by children who meet all of the following requirements:

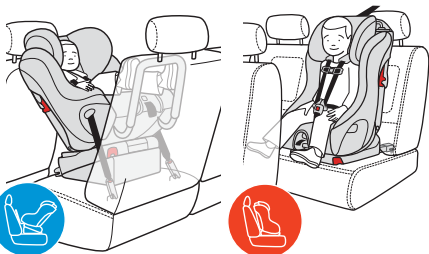

HEIGHT	WEIGHT	AGE
25 – 43 in. 64 – 110 cm	14 – 50 lb 6.4 – 22.7 kg	Able to sit upright alone



HEIGHT	WEIGHT	AGE
30 – 49 in. 76 – 124 cm	22 – 65 lb 10 – 29.5 kg	2+ years recommended (1 year min.)



WARNING

- Read and understand all information and instructions on product labels and in this manual and in your vehicle owner’s manual before installing or using this car seat.
- Failure to properly install or use this car seat or follow these warnings and those on this car seat’s labels can result in serious injury or death to the child in a sharp turn, sudden stop or crash.

Proper Setup for Installation Method

IMPORTANT: These charts are provided for guidance only and do not provide complete information for setup of this car seat — you must read and understand all of the warnings and instructions on this car seat’s labels and in this manual before installing or using this car seat.



When Using This Car Seat in Rear-Facing Mode

ALLOWABLE INSTALLATION METHOD	CHILD WEIGHT	CHILD HEIGHT	CHILD AGE (MIN REQUIREMENTS)	ALLOWABLE RECLINE POSITIONS	CROTCH BUCKLE POSITION	SHOULDER HARNESS POSITION
Lap and Shoulder Belt	14 - 50 lb	25 - 43"	Able to sit upright alone	2 or 3	Rear	At or just below shoulder
Lap Belt only						
LATCH	14 - 25 lb					

For concerns related to parts or the use and maintenance of this product, please contact us at:

Clek Inc.
Attn: Customer Service
226 Lesmill Road
Toronto, Ontario Canada
M3B 2T5

www.clekinc.com



When Using This Car Seat in Forward-Facing Mode

ALLOWABLE INSTALLATION METHOD	CHILD WEIGHT	CHILD HEIGHT	CHILD AGE (MIN REQUIREMENTS)	ALLOWABLE RECLINE POSITIONS	CROTCH BUCKLE POSITION	SHOULDER HARNESS POSITION
Lap Belt + Top Tether	22 - 65 lb	30 - 49"	2+ years recommended (1 year min.)	2 only	Front	At or just above shoulder
Lap and Shoulder Belt + Top Tether				1 or 2		
Rigid LATCH + Top Tether						
Rigid LATCH + Lap and Shoulder Belt + Top Tether						

IMPORTANT: NEVER use this car seat when installing Forward-Facing with Rigid LATCH or a lap belt, without the Top Tether.

ALWAYS secure the Top Tether provided with this car seat when installing Forward-Facing with lap/shoulder belt unless no Top Tether anchorage is available. If installing with a vehicle belt without a top tether, follow the set-up instructions below:

- choose one of the top two (2) sets of Shoulder Harness Slots at or just above and closest to the shoulders
- for children under 40lb (18.1 kg), the Crotch Strap must be through the inner Crotch Strap Slot.
- only use recline position 1.

Table of Contents

Proper Setup for Installation Method	i
When Using This Car Seat in Rear-Facing Mode	i
When Using This Car Seat in Forward-Facing Mode	ii
Car Seat Features	3
Registration & Recall Information	5
Registering Your Car Seat	6
Warnings	7
Certification	12
Child Size Limitations and Checklist for Proper use	12
When Using This Car Seat in Rear-Facing Mode	13
When Using This Car Seat in Forward-Facing Mode	15
Vehicle Information	18
Vehicle Child Restraint Anchorage System (LATCH)	18
Vehicle Seat Location Requirements	19
Vehicle Belt Requirements	21
Vehicle Belt Systems	22
Adjusting Car Seat to Fit Your Child	25
Installing Headrest	25
Adjusting Headrest	27
Crotch Strap Adjustment	28
Shoulder Harness Adjustment	30
Shoulder Harness Slot Selection	31
Shoulder Harness Unthreading	31
Shoulder Harness Rethreading	32
To Shorten The Shoulder Harness Webbing	33

© Clek and Clek logos and Foof are registered trademarks of Clek Inc.
For a complete list of Clek Inc. trademarks please visit www.clekinc.com/trademarks

Installing/Removing Rear-Facing Car Seat	35
Installing Rear-Facing Car Seat With LATCH	37
Removing Rear-Facing Car Seat Installed With LATCH	44
Installing Rear-Facing Car Seat With Vehicle Belt	46
Removing Rear-Facing Car Seat Installed With Vehicle Belt	52
Installing/Removing Forward-Facing Car Seat	54
Installing Forward-Facing Car Seat With LATCH	55
Removing Forward-Facing Car Seat Installed With LATCH	64
Installing Forward-Facing Car Seat With Vehicle Belt	66
Removing Forward-Facing Car Seat Installed With Vehicle Belt	72
Securing Your Child in Car Seat	74
Removing Your Child From Car Seat	80
Operation and Adjustments	81
Installing/Removing Rear-Facing Base	81
Removing/Installing Seat Cushion	82
Installing/Removing Anti-Rebound Bar	84
Rear-Facing LATCH storage	87
Forward-Facing Rigid LATCH Storage	89
Top Tether Storage	89
Instruction Manual Storage	90
Aircraft Installation	90
Care and Cleaning	91
Removing/Installing Seat Cushion Cover	91
Car Seat Cleaning	93
Recycling Your Car Seat	94
Troubleshooting	94
Accessories	94
Warranty	95
How to Receive Spanish Instructions	96
Cómo recibir las instrucciones en español	96

Car Seat Features – Front

- 1 Seat Cushion
- 2 Shoulder Harness Slots
- 3 Shoulder Harness Covers
- 4 Shoulder Harness Straps
- 5 Chest Clip
- 6 Buckle Tongues
- 7 Buckle
- 8 Crotch Strap
- 9 Buckle Pad
- 10 Harness Adjuster
- 11 Harness Adjuster Strap
- 12 Recline Handle
- 13 Rigid LATCH Release Handles
- 14 Rigid LATCH Adjustment Handle
- 15 Rear-Facing Belt Path
- 16 Headrest
- 17 Headrest Adjuster
- 18 Crotch Strap Slots
- 19 Rear-Facing LATCH Storage (under Seat Cushion)
- 20 Rear-Facing LATCH Belt
- 21 Rear-Facing LATCH Connectors
- 22 Rear-Facing Belt Lock-offs
- 23 Crumb Catcher (select models)
- 24 Crumb Catcher Zippers (select models)
- 25 Crotch Strap Opening (select models)

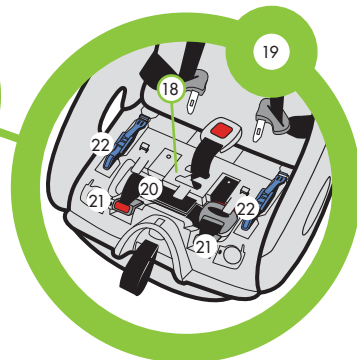
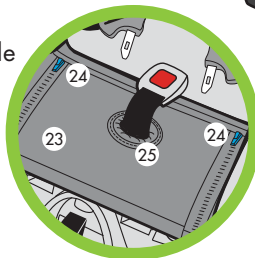
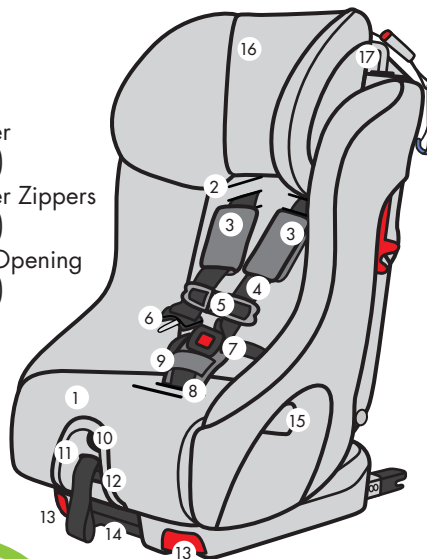

Car Seat Features – Back

- 26** Seat
- 27** Top Tether
- 28** Tether Adjuster
- 29** Tether Hook
- 30** Tether Storage (behind manual)
- 31** Forward-Facing Shoulder Belt Lock-offs
- 32** Shoulder Harness Access Panel
- 33** Troubleshooting Tool
- 34** Shoulder Harness Straps
- 35** Metal Harness Plate
- 36** Rigid LATCH Connectors (Forward-Facing Use)
- 37** Yellow and Black Rigid LATCH Label (NEVER use without Top Tether while visible)
- 38** Forward-Facing Belt Path
- 39** Instruction Manual (stored in Shoulder Harness Access Panel)
- 40** Rear-Facing Base
- 41** Rear-Facing Base Retention Hooks
- 42** Rear-Facing Base Release Lever
- 43** Anti-Rebound Bar
- 44** Anti-Rebound Bar Locking Pins and Locking Pin Clips

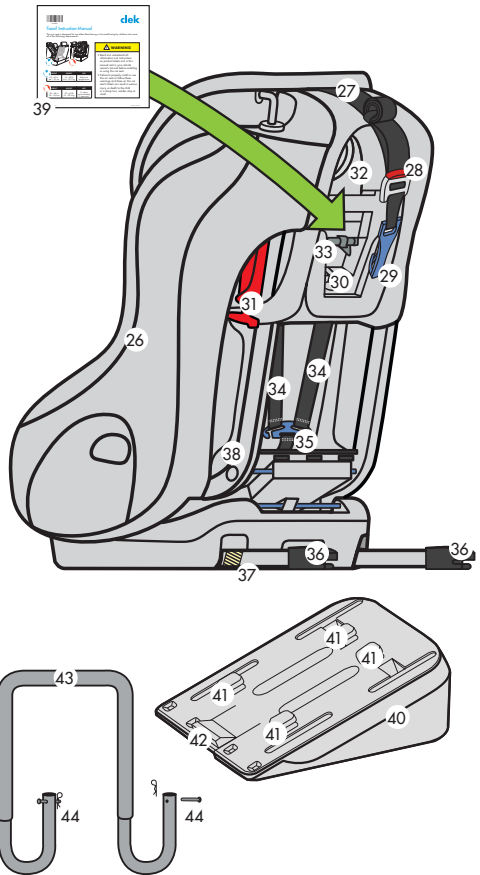

Registration & Recall Information



WARNING

- Child restraints could be recalled for safety reasons. You must register this restraint (car seat) to be reached in a recall.

Model Name: **FOONF** _____

Serial Number: _____

Manufactured In: _____
(yyyy/mm/dd)

Date of Purchase: _____

Registering Your Car Seat

Please fill in the information on the previous page for your records. The model name, serial number and manufacturing date can be found on a label affixed to the back of this Car Seat.

Fill out the prepaid registration postcard attached to the car seat and mail it today.

Child restraints could be recalled for safety reasons. You must register this restraint to be reached in a recall. Send your name, address, e-mail address if available, and the restraint's model number and manufacturing date to:

Clek Inc.
226 Lesmill Road
Toronto, Ontario, Canada M3B 2T5

or call 1-866-656-2462

or register online at: www.clekinc.com/register

For recall information, call the U.S. Government's Vehicle Safety Hotline at 1-888-327-4236 (TTY: 1-800-424-9153), or go to: <http://www.NHTSA.gov>

Warnings



WARNING – DEATH or SERIOUS INJURY can occur

Failure to properly install or use this car seat or follow these warnings and instructions and those on this car seat's labels can result in serious injury or death of the child in a sharp turn, sudden stop or crash.

- Do not install or use this car seat until you read and understand the instructions in this manual and in your vehicle owner's manual. Do not let others install or use this car seat unless they understand how to correctly install and use it.
- NEVER use this car seat Rear-Facing in a vehicle front seating location with an air bag.
- Use only with children who weigh between 14 and 65 lb (6.4–29.5 kg) and whose height is 49 in. (124 cm) or less and who are capable of sitting upright alone.
- Use only in a Rear-Facing position when using this car seat with an infant less than one year old and weighing less than 22 lb (10 kg).
- Failure to choose the correct car seat mode (Rear-Facing or Forward-Facing) and to properly secure this car seat and your child can increase the risk of injury or death.



WARNING – DEATH or SERIOUS INJURY can occur (continued)

- NEVER use this car seat with children not able to sit upright alone. Their head may fall forward, which could restrict their ability to breathe.
- Discontinue Rear-Facing use when:
 - Child’s weight exceeds 50 lb (22.7 kg).
 - Child’s height exceeds 43 in. (110 cm).
 - Child’s head is less than 1 in. (2.5 cm) from top of Headrest in highest position.
- Discontinue Forward-Facing use when:
 - Child’s weight exceeds 65 lb (29.5 kg).
 - Child’s shoulders are above the top Shoulder Harness Slots.
 - Top of child’s ears are above the top of the car seat’s Headrest in its highest adjustment position.
- This car seat must be installed by an adult.
- NEVER allow the child to buckle themselves in this car seat.
- Snugly adjust harness provided with this car seat around child.



WARNING – DEATH or SERIOUS INJURY can occur (continued)

- NEVER use this child restraint Rear-Facing without the Rear-Facing Base and Anti-Rebound Bar.
- NEVER secure car seat into vehicle with a belt around the base. Belt must ALWAYS be routed through the correct Belt Path in the seat for the mode of use (denoted by blue markings for Rear-Facing and red markings for Forward-Facing).
- NEVER use this car seat without the Headrest.
- Do not use this child restraint with motorized or door mounted belt systems.
- Secure this child restraint with the vehicle's LATCH system or with a vehicle belt and Top Tether as shown in this manual.
- LATCH system or vehicle belt must stay tightly adjusted on car seat at all times.
- When using this car seat in Rear-Facing mode with a child weighing more than 25 lb (11.4 kg), this car seat must be installed with a vehicle belt.
- When using this car seat in Forward-Facing mode with a child weighing more than 35 lb (15.9 kg), this car seat must be installed with:
 - the Rigid LATCH Connectors, the vehicle belt and the Top Tether; or
 - the vehicle belt and the Top Tether



WARNING – DEATH or SERIOUS INJURY can occur (continued)

- Rigid LATCH Connectors and Top Tether and vehicle belt can be used in combination up to 65 lb (29.5 kg) in Forward-Facing Mode only.
- NEVER use this car seat, when installed with Rigid LATCH, while the Yellow and Black Rigid LATCH Label is visible unless the Top Tether is attached as instructed in this manual.
- ALWAYS secure the Top Tether provided with this car seat when installing Forward-Facing with Rigid LATCH or a lap belt. NEVER use this car seat, when installing Forward-Facing with Rigid LATCH or a lap belt, without the Top Tether.
- ALWAYS secure the Top Tether provided with this car seat when installing Forward-Facing with lap/shoulder belt unless no Top Tether anchorage is available.
- If installing this seat Forward-Facing without the Top Tether for children under 40lb (18.1 kg), the Shoulder Harness Straps must be adjusted to the shorter shoulder harness strap length.
- Do not use this car seat after a crash of any kind. A crash can cause damage to this car seat that you cannot see.
- ALWAYS securely attach this car seat to the vehicle, even when not occupied. An unsecured car seat can injure other occupants in a crash.
- NEVER leave child unattended.



WARNING – DEATH or SERIOUS INJURY can occur (continued)

- NEVER leave child in car seat when Harness is not buckled and properly adjusted, children can strangle on loose harness straps.
- Do not use this car seat after nine (9) years from the date of manufacture. The date of manufacture can be found on the label affixed to the back of this car seat.
- Do not use accessories or parts with this car seat other than those provided by Clek Inc. Use of accessories or parts from other manufacturers could alter the performance of this car seat.
- Do not attempt to make repairs to or otherwise modify or tamper with this car seat.
- NEVER use this car seat if it is damaged or is missing parts.
- Keep this manual in the storage compartment located on the back of this car seat for future use.
- NEVER use a second-hand car seat or a car seat whose history you do not know.
- Register your child restraint with Clek Inc.
- Avoid burn injury — ALWAYS touch the surfaces that will contact your child first before putting them in this car seat. This car seat can become very hot if left in the sun and can burn your child's skin.

Certification

- This child restraint system conforms to all applicable Federal Motor Vehicle Safety Standards.
- This restraint is certified for use in Motor Vehicles and Aircraft.

Child Size Limitations and Checklist for Proper Use



WARNING

- Use only in a Rear-Facing position when using this car seat with an infant less than one year old and weighing less than 22 lb (10 kg).
- Failure to choose the correct car seat mode (Rear-Facing or Forward-Facing) and to properly secure this seat and your child can increase the risk of injury or death.
- NEVER use this seat with children not able to sit upright alone. Their head may fall forward, which could restrict their ability to breathe.

American Academy of Pediatrics (AAP) Recommendation

The AAP advises, and some states require, parents to keep their toddlers in Rear-Facing car seats until age 2, or until they reach the maximum height and weight for their seat.



When Using This Car Seat in Rear-Facing Mode

- ✓ All infants less than one year old or 22 lb (10 kg) must be Rear-Facing.
- ✓ Child's weight is between 14 and 50 lb (6.4 and 22.7 kg),
- ✓ Child's height is between 25 and 43 in. (64 and 110 cm),
- ✓ Child is able to sit upright alone.
- ✓ Car seat is securely installed in a rear vehicle seating position using either the LATCH Belt or the vehicle belt as instructed in this manual.

NOTE: If child weighs more than 25 lb (11.4 kg), this car seat must be installed with the vehicle belt.

- ✓ Car Seat is properly assembled with the Headrest, Rear-Facing Base, and the Anti-Rebound Bar properly secured.



- ✓ The top of the child's head must be at least 1 in. (2.5 cm) below the top of the car seat's Headrest, as shown in **Figure 1**.

NOTE: If the top of the child's head is less than 1 in. (2.5 cm) below the top of the Headrest in the highest adjustment position, your child is too large for using this car seat Rear-Facing and must be transitioned to using this car seat Forward-Facing.

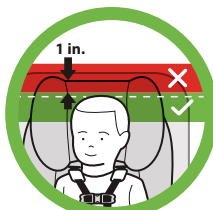

Figure 1

- ✓ The Shoulder Harness Straps must be through Shoulder Harness Slots at or below and closest to the child's shoulders, as shown in **Figure 2**.

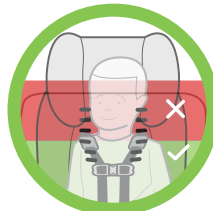

Figure 2

- ✓ The Crotch Strap should be through the inner Crotch Strap Slot.
- ✓ Bottom of Headrest is at or above the Shoulder Harness Slots in Use.
- ✓ Harness is fully secured and snugly adjusted around child.
- ✓ Car Seat must be adjusted to recline position 2 or 3, with the Rear-Facing Reference Line appropriate for the child's weight parallel to the ground.
- ✓ Car seat should not move more than 1" in any direction when grasped above the Rear-Facing belt path and pushed.



When Using This Car Seat in Forward-Facing Mode

- ✓ Child's weight is between 22 and 65 lb (10 and 29.5 kg).
- ✓ Child's height is between 30 and 49 in. (76 and 124 cm).
- ✓ Child is at least 1 year of age.
- ✓ Car seat is securely installed in a rear vehicle seating position using either the rigid LATCH Connectors and the Top Tether; the vehicle belt and Top Tether; or the rigid LATCH Connectors, the vehicle belt, and the Top Tether.

NOTE: If child weighs more than 35 lb (15.9 kg), this car seat must be installed either with the vehicle belt and the Top Tether or with the rigid LATCH lower connectors, the vehicle belt, and the Top Tether.

- ✓ Car Seat is properly assembled with the headrest properly secured. The Rear-Facing Base and Anti-Rebound Bar must be removed when using seat Forward-Facing.

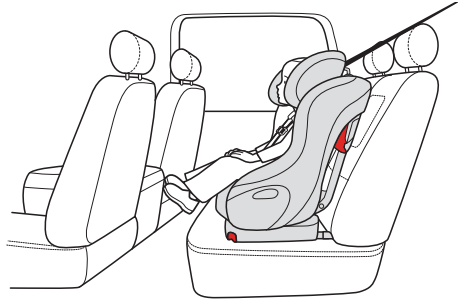

- ✓ The tops of the child's ears must be below the top of the car seat's Headrest, as shown in **Figure 3**.

NOTE: If the tops of the child's ears are above the top of this car seat's Headrest in the highest adjustment position, your child is too large for this car seat.

- ✓ The Shoulder Harness Straps must be through Shoulder Harness Slots at or above and closest to the child's shoulders, as shown in **Figure 4**, with the following exceptions:

- If installing without the Top Tether, choose one of the top two (2) sets of Shoulder Harness Slots at or just above and closest to the shoulders of your child
- If installing without the Top Tether, and with children under 40lb (18.1 kg), the Shoulder Harness Straps must be adjusted to the shorter Shoulder Harness Webbing length.

NOTE: If the child's shoulders are above the highest set of Shoulder Harness Slots in the car seat's seat back, your child is too large for this car seat.

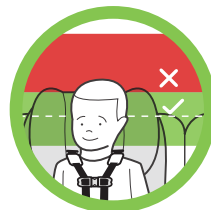

Figure 3

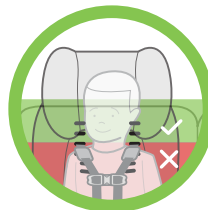

Figure 4

- ✓ The Crotch Strap must be through the outer Crotch Strap Slot and adjusted to the longer Crotch Strap length, with the following exception:
 - If installing with a vehicle belt without the Top Tether, and with children under 40lb (18.1 kg), the Crotch Strap must be through the inner Crotch Strap Slot.
- ✓ Bottom of Headrest is at or above the Shoulder Harness Slots in Use.
- ✓ Harness is fully secured and snugly adjusted around child.
- ✓ Car seat must be adjusted to a Forward-Facing recline position correct for the selected installation method, see “Proper Setup for Installation Method” section on page ii.
- ✓ Car seat should not move more than 1” in any direction when grasped at the Forward-Facing belt path and pushed.

Vehicle Information



Vehicle Child Restraint Anchorage System (LATCH)

- LATCH stands for Lower Anchors and Tethers for Children. This term refers to the anchors built into a vehicle for attaching child restraints and consists of two lower anchors at the crease between the vehicle seat back and vehicle seat cushion and a top tether anchor behind the vehicle seat as shown in **Figure 5**.
- 2003 or newer model year vehicles have at least two seating locations with a LATCH Anchorage System. Some 2001 and 2002 model year vehicles have LATCH Anchorage Systems. 2000 model year vehicles or older DO NOT have LATCH Anchorage Systems. See your vehicle owner's manual if you are unsure if your vehicle is equipped with a LATCH Anchorage System.
- See your vehicle owner's manual for seating positions which can be used with LATCH.
- If not readily visible, the LATCH lower anchors may be noted by a symbol located near the crease between the vehicle seat back and vehicle seat cushion, as shown in **Figure 6**.
- If covered, the LATCH top tether anchor locations may be identified by a symbol as shown in **Figure 7**.

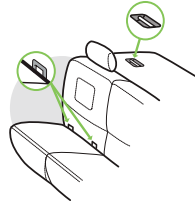

Figure 5



Figure 6



Figure 7

Vehicle Seat Location Requirements



WARNING

- According to accident statistics, children 12 and under are safer when properly restrained in the back seat rather than in the front seat.



- Before using this car seat, reference your vehicle owner's manual for:
 - Car seat installation instructions
 - Information about air bags and car seat use
 - Restrictions on combined use of LATCH and vehicle belt
- For a toddler over one year old and Forward-Facing, if a vehicle front seat location with an air bag must be used, follow the vehicle manufacturer's instructions for child restraint use and move the vehicle seat back as far as possible.



WARNING – DEATH or SERIOUS INJURY can occur

- Do not use this child restraint Rear-Facing in the front seat with an active frontal air bag. Child may be seriously injured or killed when an inflating air bag hits back of child restraint.
- NEVER use this car seat in a front vehicle seat location unless recommended by your vehicle owner's manual.
- Improper placement of this car seat in your vehicle increases the risk of serious injury or death. Some seating positions in your vehicle may not be safe for this car seat. Some vehicles do not have any seating positions that can be used safely with this car seat. If you are not sure where to place this car seat in your vehicle, consult your vehicle owner's manual or call 1-866-656-2462.

 **WARNING/AVERTENCIA/
MISE EN GARDE**

DO NOT place rear-facing child seat on front seat with air bag. DEATH OR SERIOUS INJURY can occur. The back seat is the safest place for children 12 and under.



NO colocar el asiento infantil para el automóvil enfrentado hacia atrás en el asiento delantero del vehículo que tenga un bolsa inflable de seguridad. La zona posterior del coche es el lugar más seguro para los niños de 12 años o menores.

NE PAS placer un siège d'enfant faisant face à l'arrière sur le siège avant d'un véhicule gonflable. LA MORT OU DES BLESSURES GRAVES pourraient s'en suivre. Le siège arrière est l'emplacement le plus sécuritaire pour les enfants de 12 ans et moins.

- Only install this car seat on vehicle seats that face forward. NEVER install this car seat on vehicle seats facing sideways or backwards, as shown in **Figure 8**.
- Only use this car seat on vehicle seats with seat backs that lock in an upright position. Check that the vehicle seat back is locked in an upright position recommended by the vehicle owner's manual for use when installing a car seat.



Figure 8

Vehicle Belt Requirements

Design and operation of vehicle belt systems vary from vehicle to vehicle and seating position to seating position within a vehicle. Refer to the vehicle owner's manual for information regarding car seat installation and vehicle belt use with a car seat.



WARNING

- NEVER use this car seat with a vehicle belt that is cut, damaged, frayed or inoperable.
- Using this car seat with a vehicle belt system unsafe for use with this car seat can result in serious injury or death. Pay careful attention to these systems; some of the vehicle belts that are not safe to use look very much like vehicle belts that are safe to use. If you are unsure, consult your vehicle owner's manual or call 1-866-656-2462.
- Not all vehicle belts can be used with a car seat. This car seat must be held tight at all times by the lap belt or lap portion of the lap/shoulder belt.
- This car seat may not be compatible with every inflatable lap-shoulder belt. Contact Clek Customer Service at 1-866-656-2462 for more information.
 - If installing this car seat using LATCH in a seating position equipped with an inflatable vehicle belt, do not buckle the vehicle belt behind this car seat.

Vehicle Belt Systems

- NEVER use a passive restraint — lap or shoulder belt mounted on door, as shown in **Figure 9**.
- NEVER use a passive restraint — lap belt with a motorized shoulder belt, as shown in **Figure 10**.
- Inflatable vehicle belt – lap/shoulder belt with a built-in airbag.
 - This car seat may not be compatible with every inflatable lap-shoulder belt. Contact Clek Customer Service at 1-866-656-2462 for more information.
- Buckle/Lap Belt Anchor Forward of Seat Bight – lap belt or lap belt portion of a lap/shoulder belt or buckle comes out of vehicle seat bottom forward of the seat back, as shown in **Figure 11**.
 - May not allow for secure installation of this car seat in some cases. Check for movement of car seat after installation. If car seat is not secure, DO NOT use this vehicle belt.



Figure 9



Figure 10

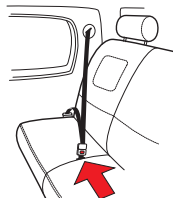

Figure 11

- Retractable Lap Belts – Lap belt is mounted on a retractor which automatically pulls the lap belt back in when released, as shown in **Figure 12**.
 - If this type of lap belt is equipped with an Emergency Locking Retractor (ELR) it should NEVER be used with this car seat.
 - If this type of lap belt is equipped with an Automatic Locking Retractor (ALR), or a Switchable Locking Retractor (SLR), it can be used. See your vehicle owner’s manual for more information on SLR retractor belts. To check if your retractable lap belt is equipped with an ALR retractor:
 1. Pull the belt all the way out until it stops.
 2. Allow the belt to pull back in about 6 in. (15 cm).
 3. Pull out on belt again. If the belt will not pull out again, it is equipped with an ALR retractor.
- Manually Adjustable Lap Belts, see **Figure 13** – Length can be manually adjusted. Does not retract into the vehicle.
 - Most manually adjustable lap belts will allow for secure installation, but if the locking latch plate slides, not providing a secure installation, it may be necessary to flip the locking latch plate over to get a secure installation as shown in **Figure 14**.

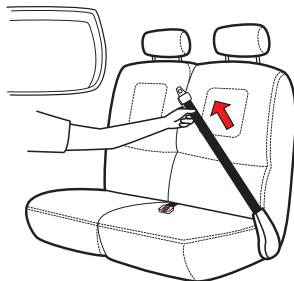

Figure 12

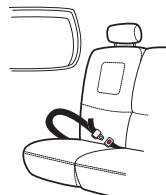

Figure 13



Figure 14

- Lap/Shoulder belts with a sliding latchplate – Shoulder belt is mounted on a retractor which automatically pulls the shoulder belt back in when released as shown in **Figure 15**. Latchplate slides freely along the webbing of the vehicle belt as shown in **Figure 16**.
 - If this type of lap/shoulder belt is equipped with an Emergency Locking Retractor (ELR), it may be used.
 - If this type of lap/shoulder belt is equipped with an ELR/ALR Switchable Locking Retractor (SLR), it can be used. To check if your lap/shoulder belt is equipped with an SLR:
 1. Slowly pull the shoulder belt all the way out until it stops.
 2. Allow the shoulder belt to pull back in about 6 in. (15 cm).
 3. Pull out on shoulder belt again. If the belt will not pull out again, it is equipped with a SLR

NOTE: Some vehicle belt systems may have a lap/shoulder belt equipped with a latchplate which appears to hold the lap portion at a fixed length when the belt is pulled tight. This type of lap/shoulder belt is compatible. It may still have a switchable locking retractor (SLR).

See your vehicle owner’s manual for more information on installing a car seat using the vehicle belt.

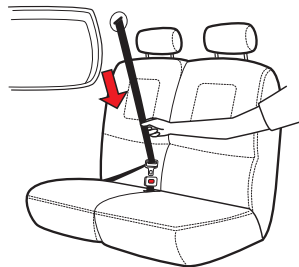

Figure 15



Figure 16

Adjusting Car Seat to Fit Your Child

**⚠ WARNING – DEATH or
SERIOUS INJURY can occur**

- NEVER use this car seat without the Headrest.

IMPORTANT: This Car Seat is shipped without the Headrest attached. The Headrest must be installed on the seat prior to use.

Installing Headrest

Step 1

Remove Tether Hook from its storage location on back of car seat. See “Top Tether Storage” on page 89.

Step 2

Locate the Troubleshooting Tool on the Shoulder Harness Access Panel and remove from storage, as shown in **Figure 17**.

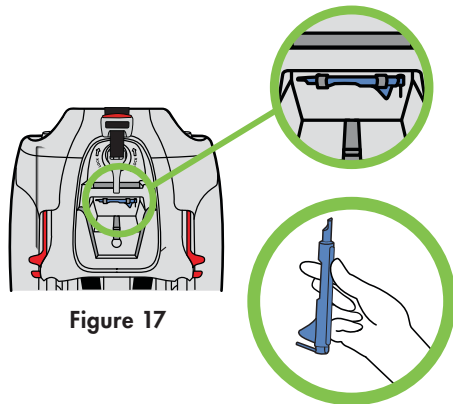

Figure 17

Step 3

Use Troubleshooting Tool to install Headrest:

- From back of car seat, place the Headrest support rods into the Headrest Guides on top of the seat back.
- Place the metal pin located on the end of the Troubleshooting Tool into the pinhole on the Headrest guide located on the right side of the seat (when facing the back of the seat) (1).
- While pressing in on Troubleshooting tool, push Headrest down until the Headrest Support Rods slide down into the seat (2), as shown in **Figure 18a**.

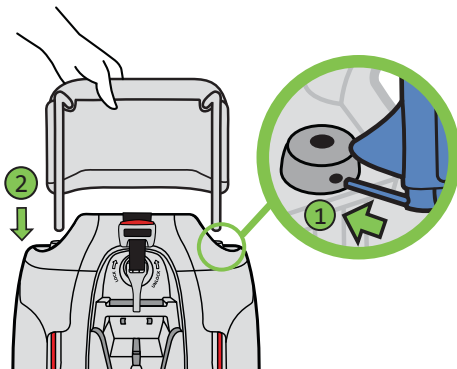

Figure 18a

Step 4

Press the button on the Headrest Adjuster located on the left-hand side of the seat (when facing back of the seat) (1), and push the Headrest down until it locks into place (2), as shown in **Figure 18b**.

Step 5

Store Troubleshooting Tool in storage spot on Shoulder Harness Access Panel.

If installing this car seat Rear-Facing, store the Top Tether. See “Top Tether Storage” on page 89.

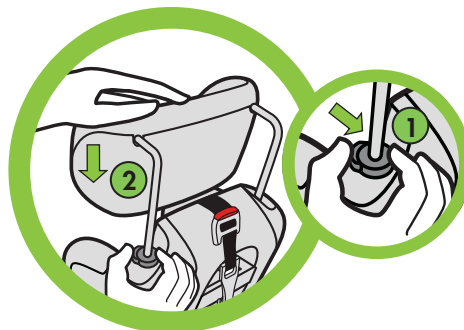

Figure 18b

Adjusting Headrest

Step 1

Press the button on the Headrest Adjuster on the right-hand side of the seat (when facing front of seat) (1) and raise or lower the Headrest into the desired position (2) as shown in **Figure 19**.

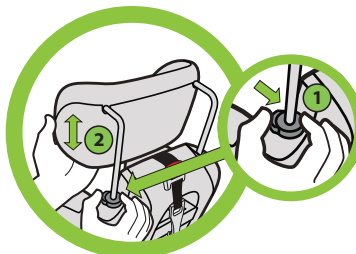

Figure 19

Step 2

Check for proper adjustment of Headrest.

The bottom of the Headrest must ALWAYS be at or above the Harness Slots in use.

Rear-Facing: The top of the child's head must be at least 1 in. (2.5 cm) below the top of the car seat's Headrest, as shown in **Figure 20**. If the top of the child's head is less than 1 in. (2.5 cm) below the top of the Headrest in the highest adjustment position, your child is too large for using this car seat Rear-Facing and must be transitioned to using this car seat Forward-Facing.

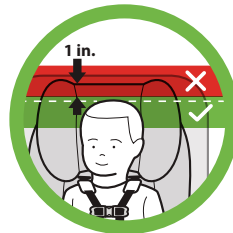

Figure 20

Forward-Facing: The tops of the child's ears must be below the top of the car seat's Headrest, as shown in **Figure 21**. If the tops of the child's ears are above the top of this car seat's Headrest in the highest adjustment position, your child is too large for this car seat.

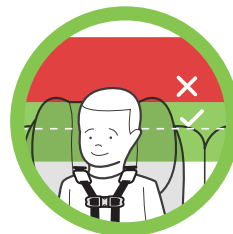

Figure 21

Crotch Strap Adjustment

Step 1

Remove the Seat Cushion. See “Removing/Installing Seat Cushion” on page 82.

If your seat has a Crumb Catcher, as shown in **Figure 22a**, unzip each zipper (1), then lift the Crumb Catcher up (2), pulling the Crotch Strap out of the Crumb Catcher (3) as shown in **Figure 22b**.

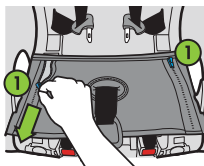

Figure 22a

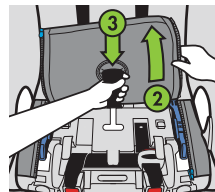

Figure 22b

Step 2

Check position of Crotch Strap:



Rear-Facing: Adjust the Crotch Strap to the inner Crotch Strap Slot as shown in **Figure 23a**.

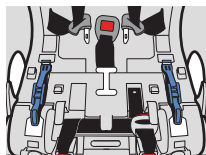

Figure 23a



Forward-Facing: Adjust the Crotch Strap to the outer Crotch Strap Slot and the longer Crotch Strap length, as shown in **Figure 23b**.

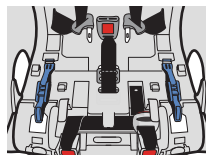

Figure 23b



IMPORTANT: If installing Forward-Facing with a vehicle belt without the Top Tether, and with children under 40lb (18.1 kg), the Crotch Strap must be through the inner Crotch Strap Slot.

TO MOVE THE CROTCH STRAP FROM ONE POSITION TO THE OTHER:

- Slide the belt to one side of the Crotch Strap Slot and push the edge of the belt into the adjustment slot as shown in **Figure 24**.
- Slide the Crotch Strap into the other Crotch Strap Slot as shown in **Figure 25a**, ensuring that the red release button on the buckle faces out of the seat as shown in **Figure 25b**.

Step 3

TO LENGTHEN OR SHORTEN THE CROTCH STRAP

- Slide the belt to one side of the Crotch Strap Slot and push the edge of the belt into the adjustment slot as shown in **Figure 26**.
- Slide the Crotch Strap out of the Crotch Strap Slot as shown in **Figure 27**.
- Select the longer (or shorter) Crotch Strap length and slide the Crotch Strap into the appropriate Crotch Strap Slot as shown in **Figure 28a**, ensuring that the red release button on the buckle faces out of the seat as shown in **Figure 28b**.

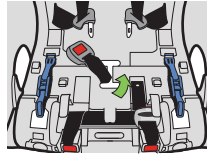

Figure 24

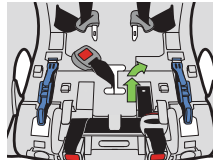

Figure 25a

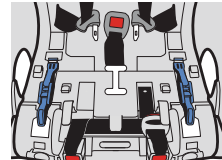

Figure 25b

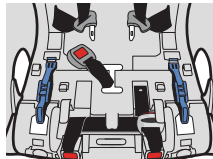

Figure 26

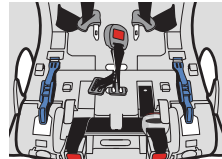

Figure 27

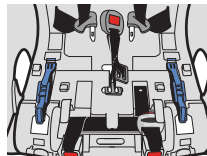

Figure 28a

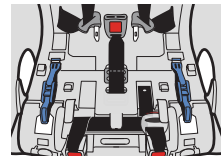

Figure 28b

Step 4

If your seat has a Crumb Catcher, insert Crotch Strap through Crotch Strap Opening, as shown in **Figure 29a**, then pull Crumb Catcher down into place and secure each zipper, as shown in **Figure 29b**.

Install the Seat Cushion. See “Removing/Installing Seat Cushion” on page 82.

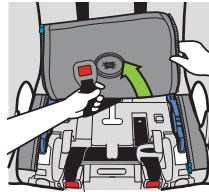

Figure 29a

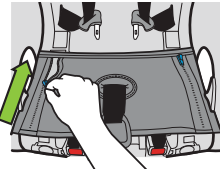

Figure 29b

Shoulder Harness Adjustment



WARNING – DEATH or SERIOUS INJURY can occur

- To prevent loose Harness and risk of ejection in a crash:
 - Loops at the end of the Shoulder Harness Straps must be properly attached to the Metal Harness Plate.
- Shoulder Harness Straps must be properly routed under bottom of seat back cover.
- Shoulder Harness Straps must be routed through Shoulder Harness Slots at the same height on each side and in the pad and seat back.
- If installing Forward-Facing without a Top Tether, and with children under 40 lbs (18.1 kg), ALWAYS use shorter Shoulder Harness Strap length.

SHOULDER HARNESS SLOT SELECTION

NOTE: This car seat has six (6) harness height positions.

Place child in seat and select the appropriate set of Shoulder Harness Slots for the direction child is facing.



Rear-Facing: Choose the Shoulder Harness Slots at or just below and closest to the shoulders of your child as shown in **Figure 30**.



Forward-Facing: Choose the Shoulder Harness Slots at or just above and closest to the shoulders of your child as shown in **Figure 31**.

IMPORTANT: If installing forward-facing without the Top Tether, choose one of the top two (2) sets of Shoulder Harness Slots at or just above and closest to the shoulders of your child.

SHOULDER HARNESS UNTHREADING

Step 1

Unbuckle Harness and separate Chest Clip.

Step 2

Loosen Harness to largest size:

- While lifting up on Harness Adjuster Tab, pull out on Shoulder Harness Straps until they stop as shown in **Figure 32**.

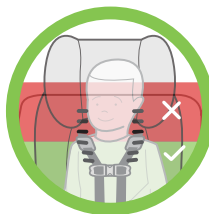

Figure 30

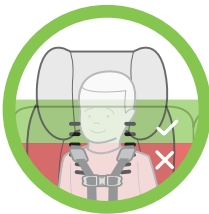

Figure 31

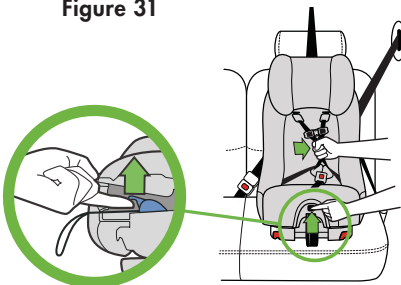

Figure 32

Step 3

Remove Tether Hook from its storage location on back of car seat. See “Top Tether Storage” on page 89.

Step 4

Remove Shoulder Harness Access Panel from back of car seat:

- Twist the Access Panel Lock counter-clockwise and pull to remove as shown in **Figure 33**.

Step 5

Remove loops at ends of Shoulder Harness Straps from Metal Harness Plate by sliding strap out through slot in Metal Harness Plate as shown in **Figure 34**.

Step 6

From front of car seat, pull Shoulder Harness Straps out of seat back.

SHOULDER HARNESS RETHREADING

Step 1

Check that Shoulder Harness Straps are not twisted and from front of seat, insert Shoulder Harness Straps through the desired Shoulder Harness Slots as shown in **Figure 35**. Straps must go through the Shoulder Harness Slots at the same height on each side.

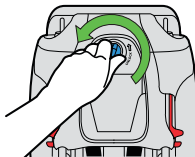

Figure 33

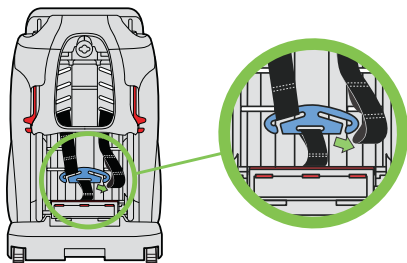

Figure 34

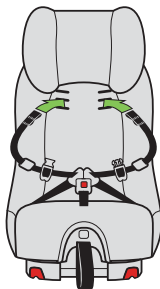

Figure 35

Step 2

Route Shoulder Harness Straps under bottom of seat back cover (1) as shown in **Figure 36**.

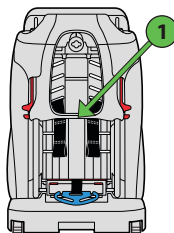

Figure 36

Step 3

Attach the Metal Harness Plate to the loop closer to the end of the Shoulder Harness Strap by sliding Harness Strap into slot in Metal Harness Plate as shown in **Figure 37**.

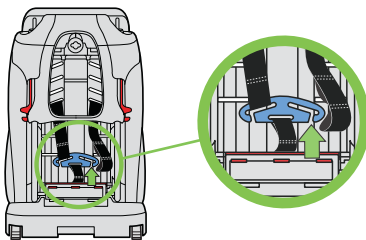

Figure 37

TO SHORTEN THE SHOULDER HARNESS WEBBING

To make the Harness smaller, attach the Metal Harness Plate to a loop further in from the end of the Shoulder Harness Strap as shown in **Figure 38**.

IMPORTANT: If installing Forward-Facing without a Top Tether, and with children under 40 lb (18.1 kg), ALWAYS use shorter Shoulder Harness Strap length.

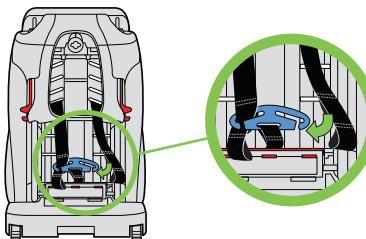

Figure 38

Check that both Shoulder Harness Straps are attached to the Metal Harness Plate on the same loop while ensuring that each Shoulder Harness Strap is completely inside the slot in Metal Harness Plate as shown in **Figure 39**.

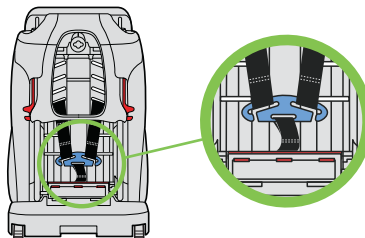

Figure 39

Step 4

Reattach Shoulder Harness Access Panel to back of car seat:

- Align Shoulder Harness Access Panel with opening in Seat Back Cover and snap in to position. Lock Access Panel in place by twisting the Access Panel Lock clockwise, as shown in **Figure 40**.

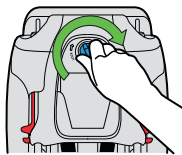

Figure 40

Step 5

If installing this car seat Rear-Facing, store the Top Tether. See “Top Tether Storage” on page 89.



Installing/Removing Rear-Facing Car Seat



WARNING – DEATH or SERIOUS INJURY can occur

- NEVER use this car seat Rear-Facing in a vehicle front seating location with an air bag.
- Rear-Facing LATCH Belt or vehicle belt must be routed through Rear-Facing Belt Path when using car seat Rear-Facing.
- The Rear-Facing Base and Anti-Rebound Bar must be used when using seat Rear-Facing.
- Rear-Facing LATCH Belt or vehicle belt must stay tightly adjusted around car seat at all times.
- Failure to properly install or use this car seat increases the risk of serious injury or death to the child and others in a sharp turn, sudden stop or crash.
- Car Seat must be installed with the Rear-Facing Reference Line appropriate for the child's weight parallel to the ground when used Rear-Facing. If the car seat is reclined too much, an infant can be ejected from the car seat in an accident. If too upright, it can cause breathing problems.



**WARNING – DEATH or
SERIOUS INJURY can occur (continued)**

- To avoid injury this car seat must be installed by an adult.
- NEVER leave this car seat unsecured in your vehicle. This car seat must remain secured even when not in use. In a sharp turn, crash or sudden stop, an unsecured car seat can be thrown around and could severely injure vehicle occupants.



Installing Rear-Facing Car Seat With LATCH

⚠ WARNING – DEATH or SERIOUS INJURY can occur

- Only use the car seat LATCH system in vehicle seating locations designated by the vehicle manufacturer for use with LATCH and that have a standard anchor spacing of 11 in. (280 mm).
- Rear-Facing LATCH Connectors must be secured to the vehicle LATCH lower anchors only. Connection to other vehicle anchors or vehicle components could result in the anchor tearing free in a crash.
- NEVER attach more than one LATCH Connector to a vehicle lower anchor unless recommended by the vehicle owner's manual for that vehicle.
- Do NOT install by this method for a child weighing more than 25 lb (11.4 kg).

LATCH



Step 1

Prepare car seat for Rear-Facing Installation:

- Fully recline car seat to Recline Position 3 by pulling Recline Handle out and rotating car seat back as shown in **Figure 41**.
- Install Rear-Facing Base to bottom of seat. See "Installing/Removing Rear-Facing Base" on page 81.
- Remove seat cushion and install Anti-Rebound Bar. See "Installing/Removing Anti-Rebound Bar" on page 84.

Note: This car seat can be used Rear-Facing in recline position 2 or 3 only.

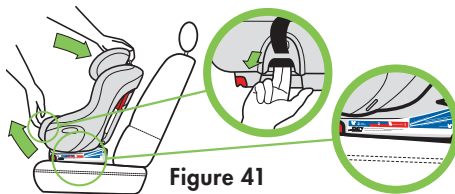
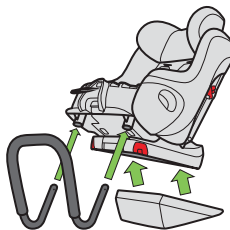

Figure 41



Step 2

Select a Forward-Facing vehicle seating location which has LATCH.

Locate the LATCH lower anchors (as explained in the "Vehicle Child Restraint Anchorage System (LATCH)" on page 18 in this manual and in your vehicle owner's manual. See **Figure 42**.

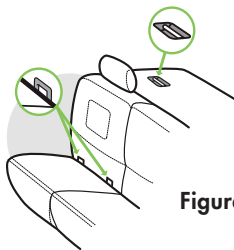

Figure 42

Step 3

If the vehicle seat back is adjustable, make sure the seat back is locked in a more upright position. Refer to vehicle owner's manual for recommended seat back angle. **DO NOT** install or use this car seat while the vehicle seat back is excessively reclined, as shown in **Figure 43**.



Figure 43

Step 4

Open both Rear-Facing Belt Lock-offs, as shown in **Figure 44**.

Check that both the top and bottom portions of each Rear-Facing Lock-off are clear of the Rear-Facing Belt Path.

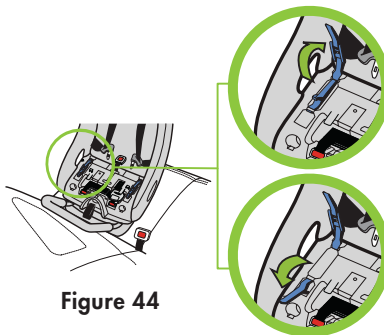

Figure 44

Step 5

Remove Rear-Facing LATCH Belt from its storage location under the Seat Cushion, see "Rear-Facing LATCH Storage" on page 87.

Lengthen Rear-Facing LATCH Belt by pressing adjuster release button while pulling belt to extend the length of Rear-Facing LATCH Belt as shown in **Figure 45**.

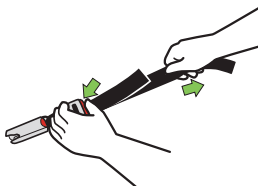

Figure 45

Step 6

Route the Rear-Facing LATCH Belt through the Rear-Facing Belt Path, as shown in **Figure 46** taking care that there are no twists in the LATCH Belt.

NOTE: Never route the LATCH Belt between the top and bottom portions of the Rear-Facing Lock-offs. Both the top and bottom portion of both Rear-Facing Lock-offs must be opened before routing LATCH belt.

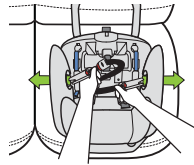

Figure 46

Step 7

Position the Rear-Facing LATCH Belt under both forward Belt Tabs as shown in **Figure 47**.

Check that Crotch Strap is not under Rear-Facing LATCH Belt.

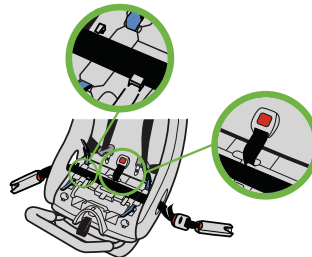

Figure 47

Step 8

Place car seat Rear-Facing in the vehicle seat location selected with Rear-Facing Belt Path toward vehicle seat back and centered between the vehicle lower anchors as shown in **Figure 48**.



Figure 48

Step 9

Secure Rear-Facing LATCH Connectors to the vehicle LATCH lower anchors. For each LATCH Connector:

- Position red release button of Rear-Facing LATCH Connector facing away from car seat.
- Align LATCH Connector with the vehicle LATCH lower anchor and press the LATCH Connector against the LATCH lower anchor until you hear the LATCH Connector click, as shown in **Figure 49**.
- Pull on LATCH Connector to check that it is securely locked on the vehicle LATCH lower anchor.

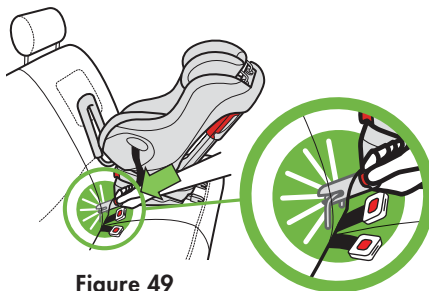

Figure 49

Step 10

Position the seat so that the Rear-Facing Level Reference Line appropriate for the child's weight is parallel with the ground as shown in **Figure 50**.

- If using with an infant under 22 lb (10 kg), position the seat with the more reclined Reference Line (top line) parallel to the ground.
- If using with an older child who is over 22 lb (10 kg), position the seat with the more upright Reference Line (bottom line) parallel to the ground.



Figure 50

Step 11

Tighten Rear-Facing LATCH Belt to secure the car seat.

- Press down in center of car seat to depress the vehicle seat cushion and pull free end of Rear-Facing LATCH Belt to tighten as shown in **Figure 51**.

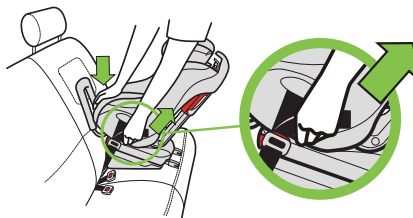

Figure 51

Step 12

Close both Rear-Facing Belt Lock-offs, as shown in **Figure 52**.

Step 13

Check for secure installation. Gripping car seat at top of armrests, pull car seat front to back and left to right to check for secure installation as shown in **Figure 53**. Rear-Facing LATCH Belt must stay tight and car seat should not move more than 1 in. (2.5 cm) in any direction.

- If Rear-Facing LATCH Belt does not stay tight or car seat cannot be securely installed, try a different LATCH location or install using the vehicle belt, see “Installing Rear-Facing Car Seat With Vehicle Belt” on page 46.

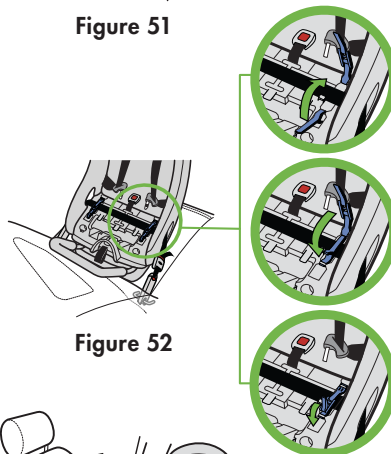

Figure 52

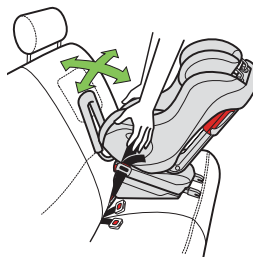

Figure 53

Step 14

Verify that the Rear-Facing Level Reference Line appropriate for the child's weight is parallel to the ground as shown in **Figure 54**. If not, go back to **Step 10** adjust the recline level and try installing again, or move the seat to a different vehicle seating position.

NOTE: If needed, a rolled towel or pool noodle may be placed under the foot end of the car seat to achieve an acceptable recline level.

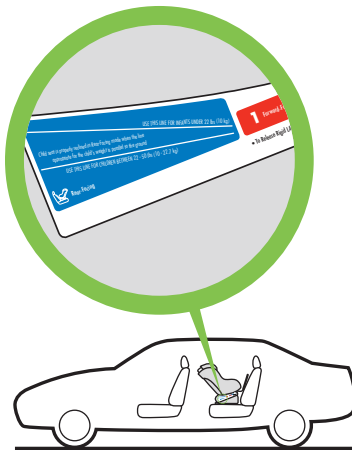

Figure 54

Step 15

If your seat has a Crumb Catcher, insert Crotch Strap through Crotch Strap Opening, as shown in **Figure 55a**, then pull Crumb Catcher down into place and secure each zipper, as shown in **Figure 55b**.

Install Seat Cushion, see "Removing/Installing Seat Cushion" on page 82.

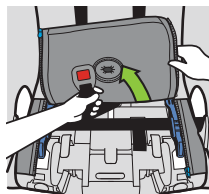

Figure 55a

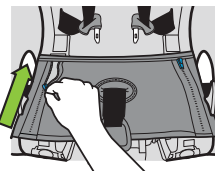

Figure 55b



Removing Rear-Facing Car Seat Installed With LATCH

Step 1

Loosen Rear-Facing LATCH Belt by pressing the adjuster button on Rear-Facing LATCH Belt adjuster and pulling out on Rear-Facing LATCH Belt as shown in **Figure 56**.

- Pressing down in center of car seat to reduce tension on Rear-Facing LATCH Belt will make it easier to loosen Rear-Facing LATCH Belt.

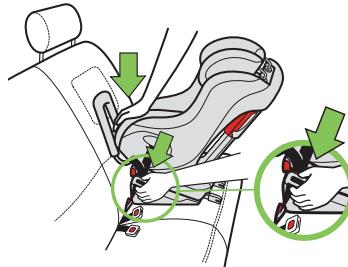

Figure 56

Step 2

Remove Seat Cushion, see “Removing/Installing Seat Cushion” on page 82.

If your seat has a Crumb Catcher, as shown in **Figure 57a**, unzip each zipper (1), then lift the Crumb Catcher up (2), pulling the Crotch Strap out of the Crumb Catcher (3) as shown in **Figure 57b**.

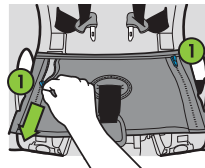

Figure 57a

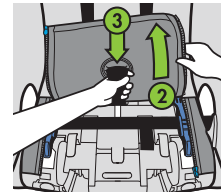

Figure 57b

Step 3

Open both Rear-Facing Belt Lock-offs as shown in **Figure 58**.

Step 4

Remove Rear-Facing LATCH Connectors from vehicle lower anchors.

- Press and hold red release button while pulling Rear-Facing LATCH Connector as shown in **Figure 59**.
- Repeat to remove Rear-Facing LATCH Connector on opposite side.

Step 5

Remove this car seat from vehicle.

Step 6

Store the Rear-Facing LATCH Belt, see “Rear-Facing LATCH Storage” on page 87.

Step 7

If your seat has a Crumb Catcher, insert Crotch Strap through Crotch Strap Opening, as shown in **Figure 60a**, then pull Crumb Catcher down into place and secure each zipper, as shown in **Figure 60b**.

Install Seat Cushion, see “Removing/Installing Seat Cushion” on page 82.

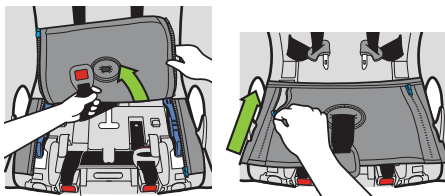
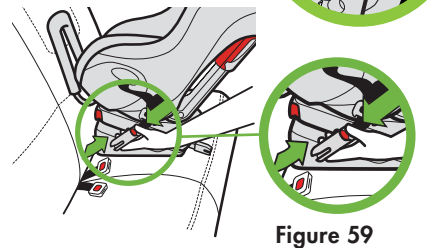
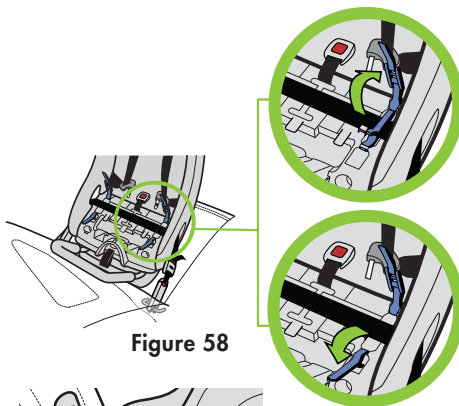



Installing Rear-Facing Car Seat With Vehicle Belt

**⚠ WARNING – DEATH or
SERIOUS INJURY can occur**

- Not all vehicle belts are safe for use with this car seat. Read the vehicle belt requirements section in this manual and your vehicle owner's manual.

Step 1

Prepare car seat for Rear-Facing Installation:

- Fully recline car seat to Recline Position 3 by pulling Recline Handle out and rotating car seat back as shown in **Figure 61**.
- Install Rear-Facing Base to bottom of seat. See "Installing/Removing Rear-Facing Base" on page 81.
- Remove Seat Cushion and install Anti-Rebound Bar. See "Installing/Removing Anti-Rebound Bar" on page 84.

Note: This car seat can be used Rear-Facing in recline position 2 or 3 only.

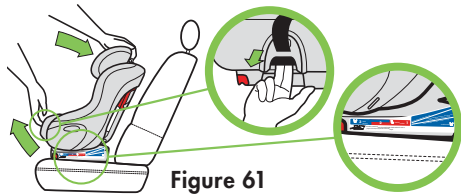
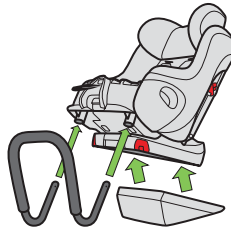

Figure 61



Step 2

Select a forward-facing vehicle seating location which has a vehicle belt which can be used with this car seat.

Step 3

If the vehicle seat back is adjustable, make sure the seat back is locked in a more upright position. Refer to vehicle owner's manual for recommended seat back angle. **DO NOT** install or use this car seat while the vehicle seat back is excessively reclined, as shown in **Figure 62**.



Figure 62

Step 4

Place car seat Rear-Facing in the vehicle seat location selected with Rear-Facing Belt Path toward vehicle seat back and centered in seating position as shown in **Figure 63**.

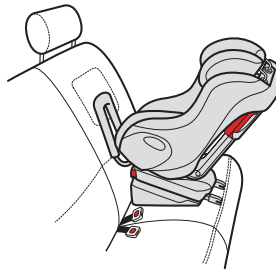

Figure 63

Step 5

Open both Rear-Facing Belt Lock-offs as shown in **Figure 64**.

Check that both the top and bottom portions of each Rear-Facing Lock-off are clear of the Rear-Facing Belt Path.

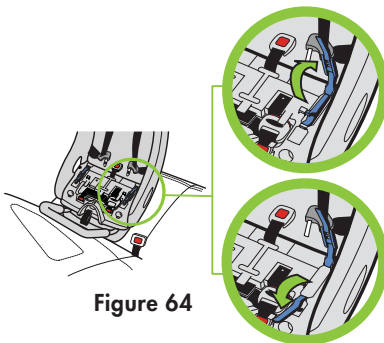

Figure 64

Step 6

Position the seat so that the Rear-Facing Level Reference Line appropriate for the child's weight is parallel with the ground as shown in **Figure 65**.

- If using with an infant under 22 lb (10 kg), position the seat with the more reclined Reference Line (top line) parallel to the ground.
- If using with an older child who is over 22 lb (10 kg), position the seat with the more upright Reference Line (bottom line) parallel to the ground.

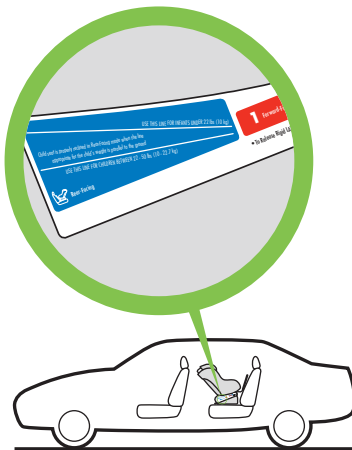

Figure 65

Step 7

Route vehicle belt through the Rear-Facing Belt Path and under both forward Belt Tabs, and buckle vehicle belt, as shown in **Figure 66**.

Check that Crotch Strap is not under the vehicle belt.

NOTE: Never route the vehicle belt between the top and bottom portions of the Rear-Facing Lock-offs. Both the top and bottom portion of both Rear-Facing Lock-offs must be opened before routing vehicle belt.

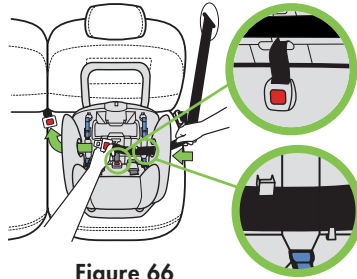

Figure 66

Step 8

Tighten vehicle belt to secure the car seat

- Press down in center of car seat to depress the vehicle cushion and pull the shoulder portion of lap/shoulder belt to tighten as shown in **Figure 67**, or pull free end of the lap belt (for lap-only belt installation) as shown in **Figure 68**.

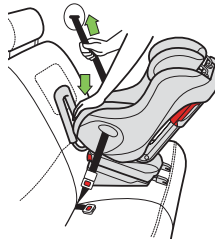

Figure 67

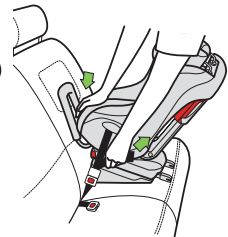

Figure 68

- While holding the vehicle belt tight, close both Rear-Facing Belt Lock-offs as shown in **Figure 69**.

Check that the entire lap/shoulder belt (both the lap and shoulder portions of the belt) or lap belt (for lap-only belt installation) is under both Rear-Facing Belt Lock-offs and under both forward Belt Tabs.

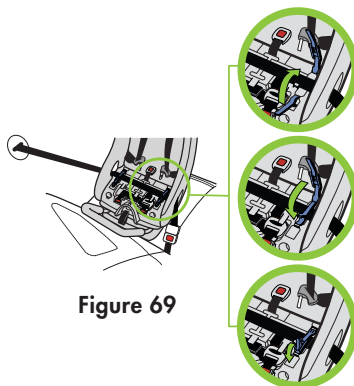

Figure 69

Step 9

Check for secure installation. Gripping car seat at top of armrests, pull car seat front to back and left to right to check for secure installation as shown in **Figure 70**. Vehicle belt must stay tight and car seat should not move more than 1 in. (2.5 cm) in any direction.

- If vehicle belt still does not stay tight or car seat cannot be securely installed, try a different vehicle seat location or install using LATCH, see “Installing Rear-Facing Car Seat With LATCH” on page 37.

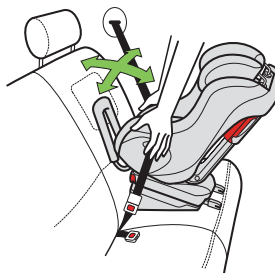

Figure 70

Step 10

Verify that the Rear-Facing Level Reference Line appropriate for the child's weight is parallel to the ground as shown in **Figure 71**. If not, go back to **Step 6**, adjust the recline level and try installing again, or move the seat to a different vehicle seating position.

NOTE: If needed, a rolled towel or pool noodle may be placed under the foot end of the car seat to achieve an acceptable recline level.

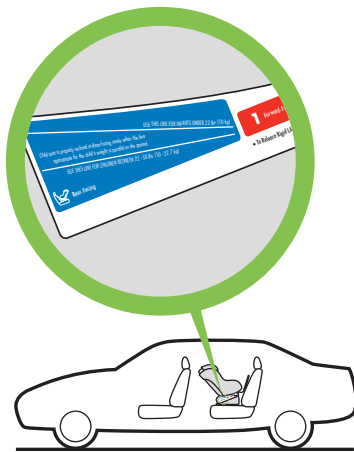

Figure 71

Step 11

If your seat has a Crumb Catcher, insert Crotch Strap through Crotch Strap Opening, as shown in **Figure 72a**, then pull Crumb Catcher down into place and secure each zipper, as shown in **Figure 72b**.

Install Seat Cushion, see "Removing/Installing Seat Cushion" on page 82.

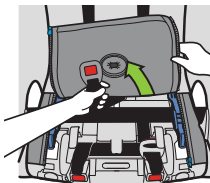

Figure 72a

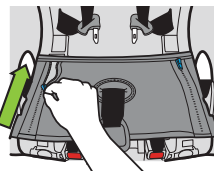

Figure 72b



Removing Rear-Facing Car Seat Installed With Vehicle Belt

Step 1

Unbuckle vehicle belt.

- Pressing down in center of car seat to reduce tension on vehicle belt will make it easier to unbuckle vehicle belt as shown in **Figure 73**.

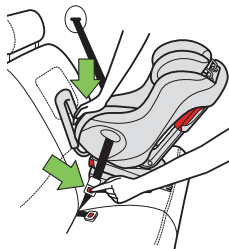

Figure 73

Step 2

Remove Seat Cushion, see “Removing/Installing Seat Cushion” on page 82.

If your seat has a Crumb Catcher, as shown in **Figure 74a**, unzip each zipper (1), then lift the Crumb Catcher up (2), pulling the Crotch Strap out of the Crumb Catcher (3) as shown in **Figure 74b**.

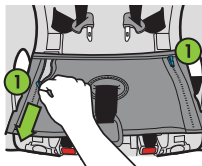

Figure 74a

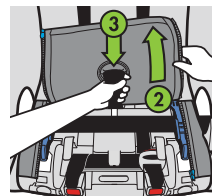

Figure 74b

Step 3

Open both Rear-Facing Belt Lock-offs as shown in **Figure 75**.

Remove vehicle belt from Rear-Facing Belt Path.

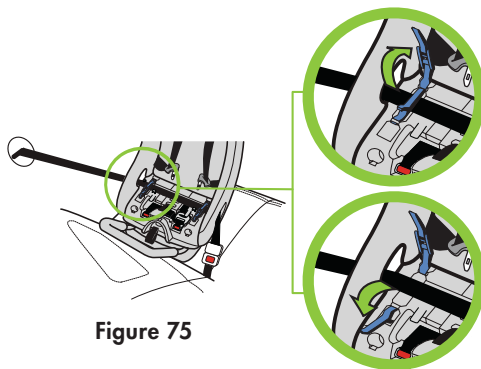

Figure 75

Step 4

Remove this car seat from vehicle.

Step 5

If your seat has a Crumb Catcher, insert Crotch Strap through Crotch Strap Opening, as shown in **Figure 76a**, then pull Crumb Catcher down into place and secure each zipper, as shown in **Figure 76b**.

Install Seat Cushion, see “Removing/Installing Seat Cushion” on page 82.

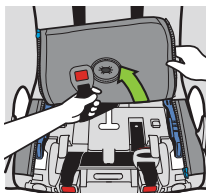

Figure 76a

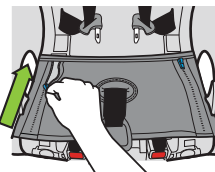

Figure 76b



Installing/Removing Forward-Facing Car Seat



WARNING – DEATH or SERIOUS INJURY can occur

- All children less than one year old and 22 lb (10 kg) must use this car seat Rear-Facing. Serious injury or death can result if infant faces front of vehicle.
- Rear-Facing Base and Anti-Rebound Bar must be removed when using seat Forward-Facing.
- LATCH or vehicle belt must stay tightly adjusted at all times.
- Seat must be in the correct recline position for the installation method selected.
- To avoid injury, this car seat must be installed by an adult.
- Do not install this car seat Forward-Facing with the Rear-Facing LATCH Belt. Only Rigid LATCH Connectors should be used to install this car seat Forward-Facing with the vehicle's LATCH anchorage system.
- Failure to properly install or use this car seat increases the risk of serious injury or death to the child and others in a sharp turn, sudden stop or crash.



Installing Forward-Facing Car Seat With LATCH

WARNING – DEATH or SERIOUS INJURY can occur

- NEVER leave this car seat unsecured in your vehicle. This car seat must remain secured even when not in use. In a sharp turn, crash or sudden stop, an unsecured car seat can be thrown around and could severely injure vehicle occupants.
- Only use this car seat LATCH system in vehicle seating locations designated by the vehicle manufacturer for use with LATCH and that have a standard anchor spacing of 11 in. (280 mm).
- Rigid LATCH Connectors must be secured to the vehicle LATCH lower anchors only. Connection to other vehicle anchors or vehicle components could result in the anchor tearing free in a crash.
- NEVER attach more than one LATCH connector to a vehicle lower anchor unless recommended by the vehicle owner's manual for that vehicle.
- ALWAYS secure the Top Tether provided with this car seat when installing Forward-Facing with Rigid LATCH. NEVER use this car seat, when installing Forward-Facing with Rigid LATCH without the Top Tether.

**⚠ WARNING – DEATH or
SERIOUS INJURY can occur (continued)**

- Do NOT install by this method for a child weighing more than 35 lb (15.9 kg).
- For children over 35 lb (15.9 kg), LATCH and Vehicle Belt can be used in combination up to 65 lb (29.5 kg) in Forward-Facing Mode only.
- NEVER use this car seat, when installed with Rigid LATCH, while the Yellow and Black Rigid LATCH Label is visible, as shown in **Figure A**, unless the Top Tether is attached as instructed in this manual.

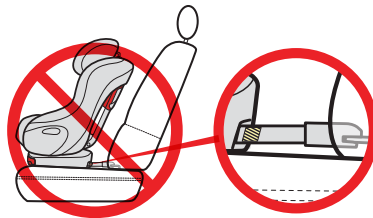
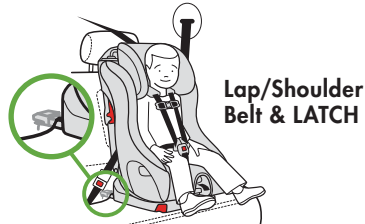
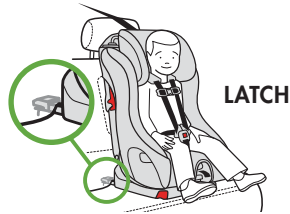

Step 1

Prepare car seat for Forward-Facing Installation:

- If Rear-Facing Base or Anti-Rebound Bar is attached, remove it now, see “Installing/Removing Rear-Facing Base” on page 81 and “Installing/Removing Anti-Rebound Bar” on page 84.

Step 2

Select a Forward-Facing vehicle seating location which has LATCH.

Locate the LATCH lower anchors and top tether anchor (as explained in the “Vehicle Child Restraint Anchorage System (LATCH)” on page 18 in this manual and in your vehicle owner’s manual). See **Figure 77**.

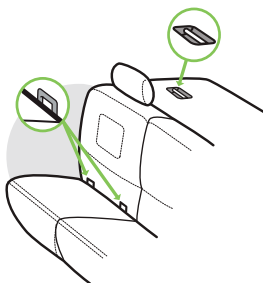

Figure 77

Step 3

If the vehicle seat back is adjustable, make sure the seat back is locked in a more upright position. Refer to vehicle owner’s manual for recommended seat back angle. **DO NOT** install or use this car seat while the vehicle seat back is excessively reclined, as shown in **Figure 78**.



Figure 78

Step 4

Adjust car seat to Recline Position 1 or 2 by pulling recline handle out and rotating car seat as shown in **Figure 79**.

IMPORTANT: Never use recline position 1 when installed with LATCH, Forward-Facing, and without the Top Tether.

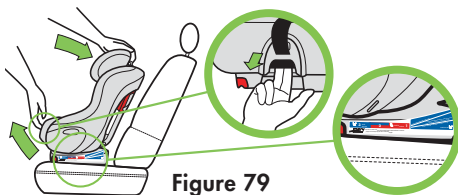

Figure 79

Step 5

Pull Rigid LATCH Connectors to the fully extended position as shown in **Figure 80**.

- Pull and hold Rigid LATCH Adjustment Handle.
- Grasp the back of the Rigid LATCH Connectors and pull out until they stop.
- Release Rigid LATCH Adjustment Handle.

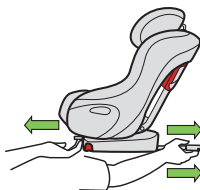

Figure 80

Step 6

Remove Tether Hook from its storage location on back of car seat. See “Top Tether Storage” on page 89.

- Lengthen Top Tether belt by pressing and holding Tether Adjuster while pulling strap as shown in **Figure 81**.
- Place Tether Hook in the seat of the car seat.

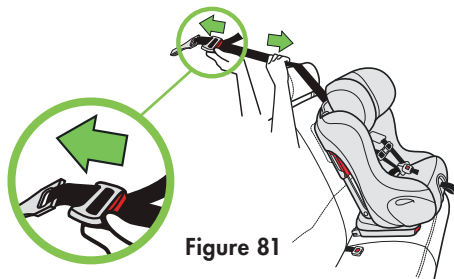

Figure 81

Step 7 (If installing with LATCH and vehicle belt)

This car seat may be installed forward-facing with both LATCH and the vehicle belt. This type of installation will allow the LATCH to be used until the child reaches the maximum size requirements of the seat.

IMPORTANT: NEVER install this car seat using both LATCH and vehicle belt if prohibited in the vehicle's owner's manual or if either of the conditions shown in **Figures 82** and **83** exist.

Secure car seat with vehicle belt:

- Route vehicle belt through the Forward-Facing Belt Path, taking care not to put vehicle belt between Harness and back of seat, and buckle vehicle belt, as shown in **Figure 84**.
- Open the Forward-Facing Belt Lock-off on the same side of the seat as the vehicle shoulder belt anchor point. Place the vehicle shoulder belt through the Forward-Facing Belt Lock-off as shown in **Figure 85**.

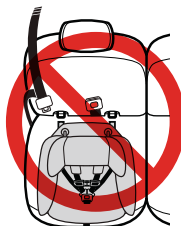

Figure 82

Vehicle belt buckle is located in between LATCH lower anchors

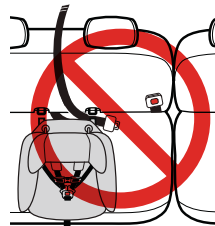

Figure 83

Vehicle belt is located in between LATCH lower anchors

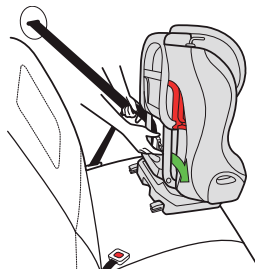

Figure 84

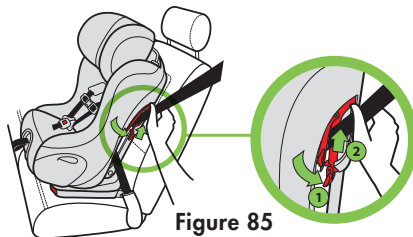

Figure 85

Step 8

Place car seat in the seating location selected with the Rigid LATCH Connectors facing the vehicle seat.

Secure the Rigid LATCH Connectors to the vehicle LATCH lower anchors by aligning the Rigid LATCH Connectors with the vehicle LATCH lower anchors and pressing the Rigid LATCH Connectors against the LATCH lower anchors until each Rigid LATCH Connector locks, as shown in **Figure 86**.

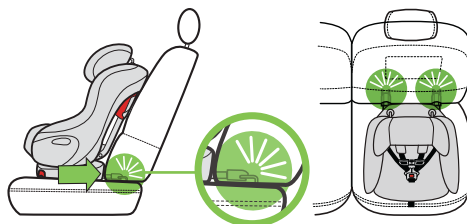

Figure 86

Step 9

Once the Rigid LATCH Connectors are connected to the LATCH lower anchors, check both LATCH Connector lock indicators located behind the Rigid LATCH Connectors to make sure they have changed from completely red (unlocked) to mostly green (locked) as shown in **Figure 87**.

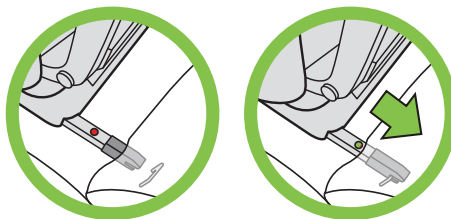

Figure 87

Pull forward on this car seat to make sure it is securely attached to the vehicle's LATCH lower anchors on both sides. If not, go back to **Step 8**.

NOTE: It may be necessary to adjust the car seat to recline position 1 in some vehicles in order to connect Rigid LATCH Connectors to the vehicle lower anchors. If Rigid LATCH Connectors cannot be successfully connected in this seating position, it may be necessary to go back to **Step 2** and try a different seating position.

IMPORTANT: If Rigid LATCH Connectors fail to connect to the vehicle's LATCH lower anchors, you can still use this seat. See "Installing Forward-Facing Car Seat With Vehicle Belt" on page 66 of this manual. Please notify Clek Customer Service if the Rigid LATCH Connectors fail to latch by calling 1-866-656-2462.

Step 10

Adjust seat to fit snugly against the vehicle seat back as shown in **Figure 88**.

- Pull and hold Rigid LATCH Adjustment Handle.
- Push car seat firmly into vehicle seat back.
- Release Rigid LATCH Adjustment Handle.

If installing with LATCH and the vehicle belt:

- Pull shoulder portion of lap/shoulder belt to remove excess slack as shown in **Figure 89**.
- While holding the vehicle belt tight, lock Forward-Facing Belt Lock-off as shown in **Figure 90**.

NOTE: Use only one Shoulder Belt Lock-Off at a time. NEVER use both in the Forward-Facing Mode.

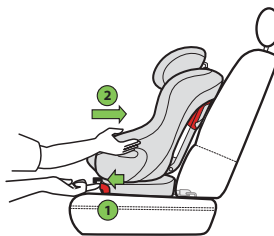

Figure 88

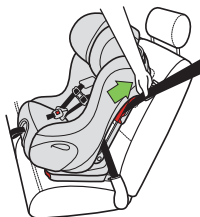

Figure 89

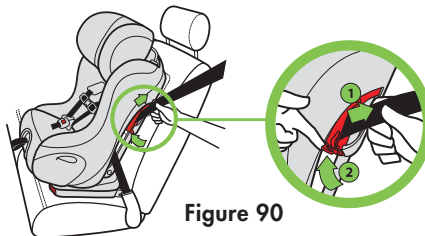

Figure 90

Step 11

Check fit against the vehicle seat back. If the back of this car seat cannot be adjusted to be in contact with the vehicle seat back as shown in **Figure 91**, try changing the recline position of this car seat, verify that the vehicle seat back is in a more upright position and re-adjust.

If this seat cannot be positioned so that car seat back is in contact with the vehicle seat back, try a different LATCH equipped vehicle seating position, or install with a vehicle belt, see "Installing Forward-Facing Car Seat With Vehicle Belt" on page 66 of this manual.

A small gap between the top or bottom of the car seat and vehicle seat back is acceptable as long as there is contact with the front surface of the vehicle seat back or headrest.

Figure 92 shows an unacceptable gap.



Figure 91



Figure 92

Step 12

Attach Tether Hook to vehicle top tether anchor as shown in **Figure 93a** or **Figure 93b** and pull firmly on free end of strap until Top Tether is snug.

Refer to vehicle owner's manual for recommended Top Tether routing and identification of top tether anchor point.

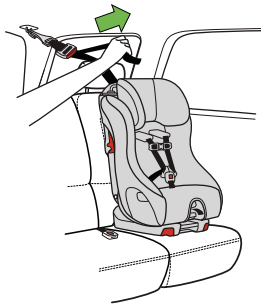

Figure 93a

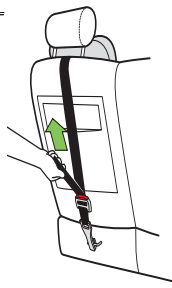

Figure 93b

Step 13

Check for secure installation. Gripping car seat at top of armrests, pull car seat front to back and left to right to check for secure installation as shown in **Figure 94**. LATCH system and Top Tether must stay tight and car seat should not move more than 1 in. (2.5 cm) in any direction.

- If LATCH system does not stay tight or car seat cannot be securely installed, try a different LATCH location or install using the vehicle belt, see "Installing Forward-Facing Car Seat With Vehicle Belt" on page 66.



Figure 94



Removing Forward-Facing Car Seat Installed With LATCH

Step 1

Loosen Top Tether belt by pressing and holding Tether Adjuster while pulling strap as shown in **Figure 95**.

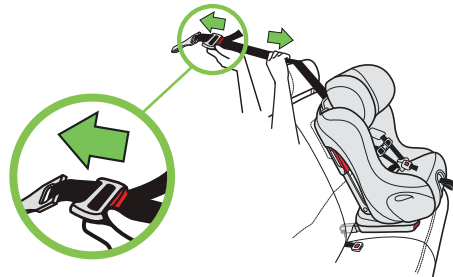

Figure 95

Step 2

Remove Tether Hook from vehicle tether anchor.

- Pull in and hold retention spring on Tether Hook, then remove Tether Hook from tether anchor as shown in **Figure 96a** and **Figure 96b**.

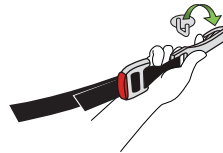

Figure 96a

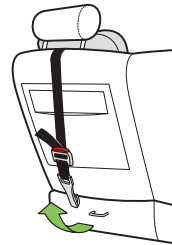

Figure 96b

Step 3

If installed with LATCH and the vehicle belt, open Forward-Facing Belt Lock-off as shown in **Figure 97**.

Unbuckle vehicle belt and remove from Forward-Facing Belt Path.

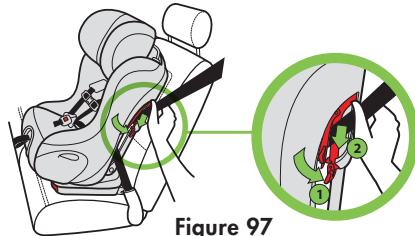

Figure 97

Step 4

Pull Rigid LATCH Connectors to the fully extended position as shown in **Figure 98**.

- Pull and hold Rigid LATCH Adjustment Handle.
- Grasp the seat and slide it out until it stops.
- Release Rigid LATCH Adjustment Handle.

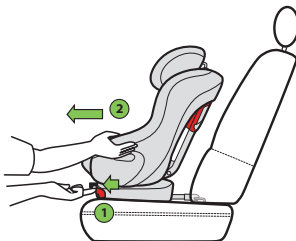

Figure 98

Step 5

Pull the red Rigid LATCH Release Handles, one at a time and pull the car seat forward to remove each Rigid LATCH Connector from the vehicle LATCH lower anchor as shown in **Figure 99**.

IMPORTANT: Rigid LATCH Connectors CANNOT be released unless they are FULLY extended.

NOTE: Moving the car seat slightly from front to back or side to side may make it easier to release the Rigid LATCH Connectors from the vehicle LATCH lower anchors.

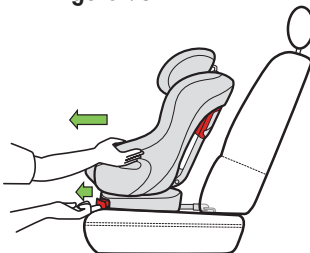

Figure 99

Step 6

Remove this car seat from vehicle.

Step 7

Store the Top Tether and Rigid LATCH Connectors, see “Top Tether Storage” and “Forward-Facing Rigid LATCH Storage” on page 89.



Installing Forward-Facing Car Seat With Vehicle Belt

**⚠ WARNING – DEATH or
SERIOUS INJURY can occur**

- Vehicle belt must be routed through Forward-Facing Belt Path when using car seat Forward-Facing.
- Forward-Facing Belt Lock-off must be used when installing with lap/shoulder belt.
- Not all vehicle belts are safe for use with this car seat. Read the “Vehicle Belt Requirements” section in this manual and your vehicle owner’s manual.
- ALWAYS secure the Top Tether provided with this car seat when installing Forward-Facing with a lap belt. NEVER use this car seat, when installing Forward-Facing with a lap belt, without the Top Tether.
- ALWAYS secure the Top Tether provided with this car seat when installing Forward-Facing with lap/shoulder belt unless no Top Tether anchorage is available.

Step 1

Prepare car seat for Forward-Facing Installation:

- If Rear-Facing Base or Anti-Rebound Bar is attached, remove it now, see “Installing/Removing Rear-Facing Base” on page 81, and “Installing/Removing Anti-Rebound Bar” on page 84.

Step 2

Select a Forward-Facing vehicle seating location which has a vehicle belt which can be used with this seat and a top tether anchor point.

Step 3

If the vehicle seat back is adjustable, make sure the seat back is locked in a more upright position. Refer to vehicle owner’s manual for recommended seat back angle. **DO NOT** install or use this car seat while the vehicle seat back is excessively reclined, as shown in **Figure 100**.



Figure 100

Step 4

Adjust car seat to the correct recline position for the installation method selected by pulling recline handle out and rotating car seat as shown in **Figure 101**.

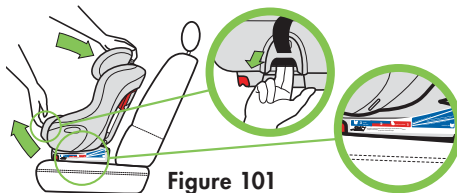

See the Forward-Facing Recline Position Chart below for correct recline position selection.

RECLINE POSITION	LAP & SHOULDER BELT + TOP TETHER	LAP-ONLY BELT + TOP TETHER	VEHICLE BELT WITHOUT TOP TETHER
1	✓	✗	✓
2	✓	✓	✗
3	✗	✗	✗

Step 5

Remove Tether Hook from its storage location on back of car seat. See “Top Tether Storage” on page 89.

- Lengthen Top Tether belt by pressing and holding Tether Adjuster while pulling strap as shown in **Figure 102**.
- Place Tether Hook in the seat of the car seat.

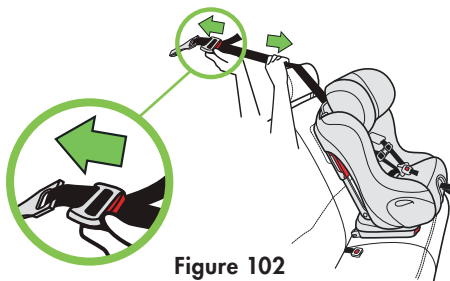

Step 6

Place car seat Forward-Facing in the vehicle seat location selected with Forward-Facing Belt Path toward vehicle seat back and centered in seating position as shown in **Figure 103**.

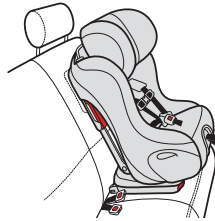

Figure 103

Step 7

Route vehicle belt through the Forward-Facing Belt Path, taking care not to put vehicle belt between Harness and back of seat, and buckle vehicle belt, as shown in **Figure 104**.

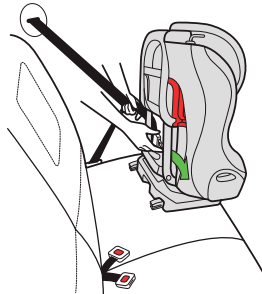

Figure 104

Step 8

If installing with a lap/shoulder belt, open the Forward-Facing Belt Lock-off on the same side of the seat as the vehicle shoulder belt anchor point. Place the vehicle shoulder belt through the Forward-Facing Belt Lock-off as shown in **Figure 105**.

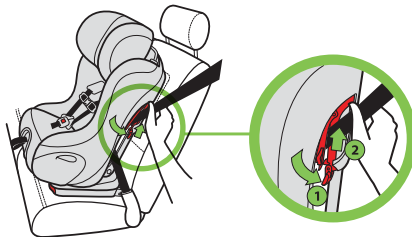

Figure 105

Step 9

Check that the entire belt is laying flat, placed correctly in the Forward-Facing Belt Path as shown in **Figure 106** (lap belt only) and **Figure 107** (lap/ shoulder belt) and NOT between the Harness and seat.

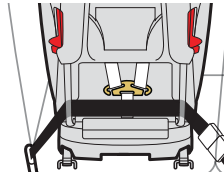

Figure 106

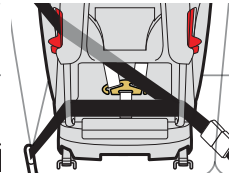

Figure 107

Step 10

Tighten vehicle belt to secure the car seat.

- Press down in center of car seat to depress the vehicle cushion and pull free end lap belt only or shoulder portion of lap/shoulder belt to tighten as shown in **Figure 108** (lap belt only) or **Figure 109** (lap/shoulder belt).

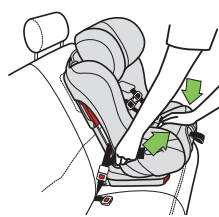

Figure 108

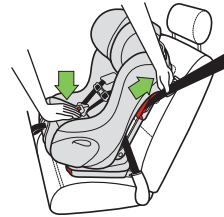

Figure 109

- If using a lap/shoulder belt: while holding the vehicle belt tight, lock Forward-Facing Belt Lock-off as shown in **Figure 110**.

NOTE: Use only one Forward-Facing Belt Lock-Off at a time. NEVER use both in the Forward-Facing Mode.

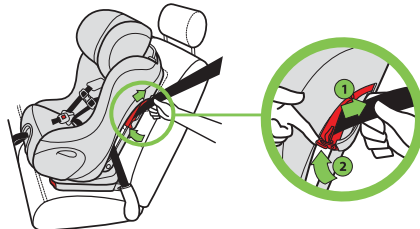

Figure 110

Step 11

Attach Tether Hook to vehicle top tether anchor as shown in **Figure 111** or **Figure 112** and pull firmly on free end of strap until Top Tether is snug.

Refer to vehicle owner's manual for recommended Top Tether routing and identification of top tether anchor point

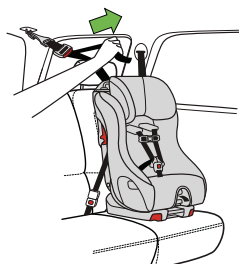

Figure 111

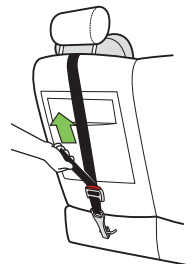

Figure 112

Step 12

Check for secure installation. Gripping car seat at top of armrests, pull car seat front to back and left to right to check for secure installation as shown in **Figure 113**. Vehicle belt and Top Tether must stay tight and car seat should not move more than 1 in. (2.5 cm) in any direction.

- If vehicle belt does not stay tight or car seat cannot be securely installed, try a different vehicle seating location or install using LATCH, see “Installing Forward-Facing Car Seat With LATCH” on page 55.

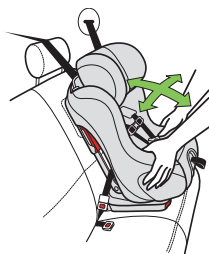

Figure 113



Removing Forward-Facing Car Seat Installed With Vehicle Belt

Step 1

Loosen Top Tether by pressing and holding Tether Adjuster while pulling strap as shown in **Figure 114**.

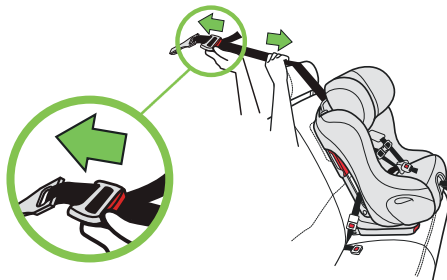

Figure 114

Step 2

Remove Tether Hook from vehicle tether anchor.

- Pull in and hold retention spring on Tether Hook, then remove Tether Hook from tether anchor as shown in **Figure 115**.

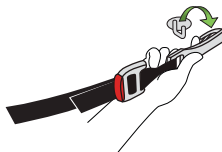

Figure 115

Step 3

Unbuckle vehicle belt.

- Pressing down in center of car seat to reduce tension on vehicle belt will make it easier to unbuckle vehicle belt as shown in **Figure 116**.

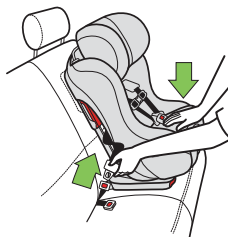

Figure 116

Step 4

Open Forward-Facing Belt Lock-off as shown in **Figure 117**.

Remove vehicle belt from Forward-Facing Belt Path.

Step 5

Remove this car seat from vehicle.

Step 6

Store the Top Tether, see “Top Tether Storage” on page 89.

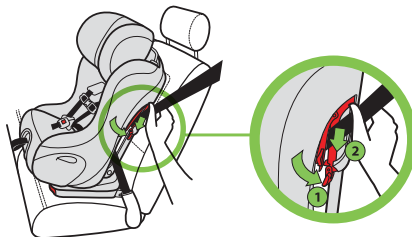

Figure 117

Securing Your Child in Car Seat



WARNING – DEATH or SERIOUS INJURY can occur

- Check that Harness fits child snugly each time they are buckled into seat.
- To avoid injury, child must be secured by an adult. NEVER allow the child to buckle themselves in this car seat.
- Child must be dressed in clothing with arms and legs that will not interfere with buckling and snugly adjusting Harness.
- NEVER place blankets between Harness and child.
- Prevent death from heat exposure: NEVER leave child unattended, even when sleeping. Vehicle interiors can reach very high temperatures quickly, even when it is not a hot or sunny day.
- Strangulation hazard: child can strangle in loose Harness Straps. NEVER leave child in car seat when Harness Straps are loose or undone.
- The bottom of the Headrest must ALWAYS be at or above the Shoulder Harness Slots in use.

Step 1

Loosen Harness:

- While lifting up on Harness Adjuster Tab, pull out on Shoulder Harness Straps as shown in **Figure 118**.

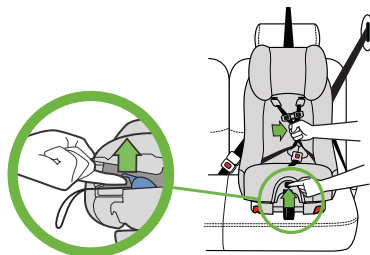

Figure 118

Step 2

Place child in car seat with their back flat against the Seat Back as shown in **Figure 119**.

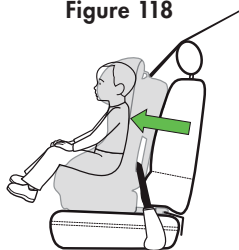

Figure 119

Step 3

Place child's arms through Shoulder Harness Straps and position the Straps over child's shoulders and thighs.

Step 4 (for Rear-Facing use only)

Recheck that the Rear-Facing Level Reference Line appropriate for the child's weight is parallel to the ground, as shown in **Figure 120**, and adjust if necessary. See "Installing/Removing Rear-Facing Car Seat" on page 35 if adjustment is required.



Figure 120

Step 5

Check position of Shoulder Harness.



Rear-Facing: The Shoulder Harness Straps must be through Shoulder Harness Slots at or below and closest to the child's shoulders, as shown in **Figure 121**.

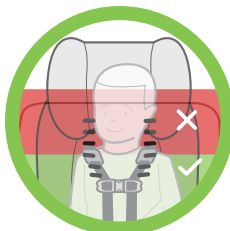

Figure 121



Forward-Facing: The Shoulder Harness Straps must be through Shoulder Harness Slots at or just above and closest to the shoulders of your child as shown in **Figure 122**.

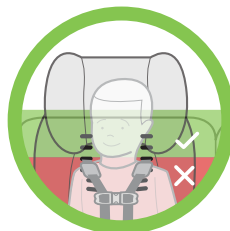

Figure 122

IMPORTANT: If installing Forward-Facing without the Top Tether:

- Choose one of the top two (2) sets of Shoulder Harness Slots at or just above and closest to the shoulders of your child.
- With children under 40 lb (18.1 kg), adjust the Harness to the shorter Shoulder Harness Strap length.

See “Shoulder Harness Adjustment” on page 30 to change position or length of Shoulder Harness Straps.

Step 6

Check Position of Headrest:

The bottom of the Headrest must ALWAYS be at or above the Harness Slots in use.



Rear-Facing: The top of the child's head must be at least 1 in. (2.5 cm) below the top of the car seat's Headrest, as shown in **Figure 123**. If the top of the child's head is less than 1 in. (2.5 cm) below the top of the Headrest in the highest adjustment position, your child is too large for using this car seat Rear-Facing and must be transitioned to using this car seat Forward-Facing.



Figure 123



Forward-Facing: The tops of the child's ears must be below the top of the car seat's Headrest, as shown in **Figure 124**. If the tops of the ears are above the top of this car seat's Headrest in the highest adjustment position, your child is too large for this car seat.

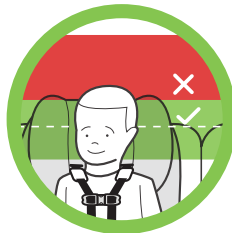

Figure 124

See "Adjusting Headrest" on page 27 to change Headrest position.

Step 7

Check position of Crotch Strap:



Rear-Facing: The Crotch Strap should be positioned in the inner Crotch Strap Slot as shown in **Figure 125**.

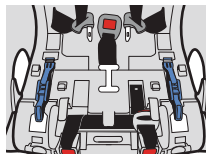

Figure 125



Forward-Facing: The Crotch Strap must be adjusted to the longer Crotch Strap length and positioned in the outer Crotch Strap Slot, as shown in **Figure 126**.

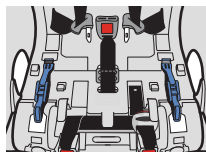

Figure 126

IMPORTANT: If installing Forward-Facing with a vehicle belt without a Top Tether, and with children under 40lb (18.1 kg), the Crotch Strap must be through the inner Crotch Strap Slot.

See “Crotch Strap Adjustment” on page 28 to change the position or length of the Crotch Strap.

Step 8

Buckle Harness:

- Insert Buckle Tongues into Buckle one at a time as shown in **Figure 127**. You should hear a click.
- Pull up on tongues to check that they are securely locked.

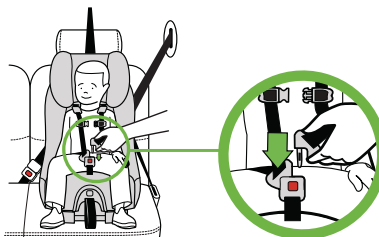

Figure 127

Step 9

Pull Harness Adjuster Strap to snugly adjust Harness Straps as shown in **Figure 128**.

- Check that Harness Straps are snug on shoulder and thighs.
- A snug Harness should not allow any slack. It lies in a relatively straight line without sagging. It does not press on the child's flesh or push the child's body into an unnatural position.

NOTE: If Harness cannot be snugly adjusted as described above, see step 3 of "Shoulder Harness Rethreading" on page 33 to make the harness smaller.

Step 10

Close Chest Clip and position Chest Clip at arm pit level as shown in **Figure 129**.

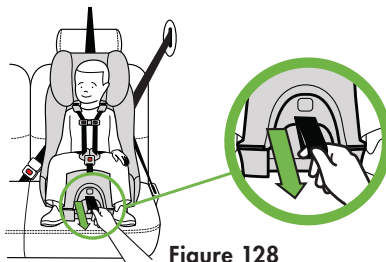

Figure 128

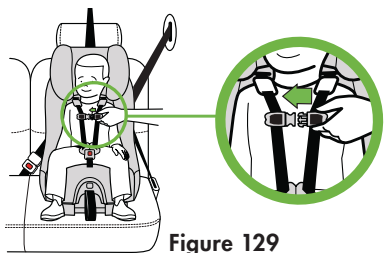

Figure 129

Removing Your Child From Car Seat

Step 1

Separate Chest Clip by squeezing release tabs together (1) and pulling Chest Clip apart (2) as shown in **Figure 130**.

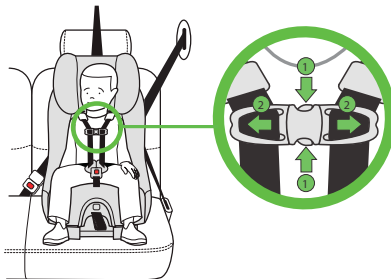

Figure 130

Step 2

Unbuckle Harness by pressing red release button on Buckle as shown in **Figure 131**.

Step 3

Loosen the Harness and remove child's arms from Harness and remove them from car seat.

NOTE: To keep the Harness out of the way for easier placement or removal of your child, place the Buckle Tongues between the fabric and the plastic panel on the exterior of the child seat.

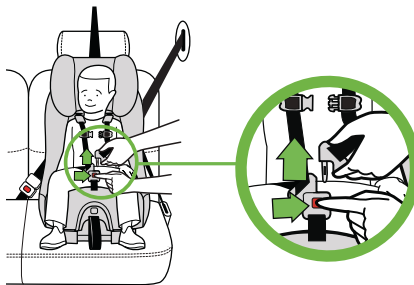

Figure 131

Operations and Adjustments

Installing/Removing Rear-Facing Base

TO INSTALL REAR-FACING BASE

Step 1

Place the car seat on a clean, stable surface with the inside of the seat facing down.

Step 2

Line the Rear-Facing Base Retention Hooks up with the openings in the bottom of the car seat, as shown in **Figure 132**. Insert the Rear-Facing Base Retention Hooks into the openings and slide the base down until you hear the Rear-Facing Base Release Lever “click” to lock the base on as shown in **Figure 133**.

Step 3

Pull up on Rear-Facing Base to check that it is locked in place.

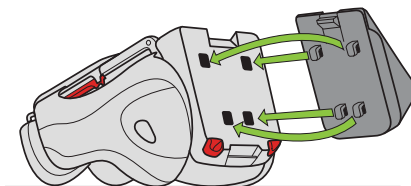

Figure 132

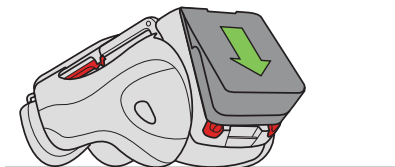

Figure 133

TO REMOVE REAR-FACING BASE

Step 1

Place the car seat on a clean, stable surface with the inside of the seat facing down.

Step 2

Pull Rear-Facing Base Release Lever away from the car seat and move the Rear-Facing Base up to release it as shown in **Figure 134**.

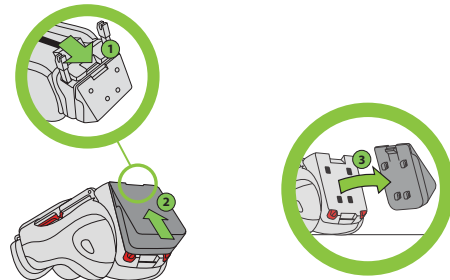

Figure 134

Removing/Installing Seat Cushion

**⚠ WARNING – DEATH or
SERIOUS INJURY can occur**

- NEVER use this car seat without the Seat Cushion in place.

TO REMOVE SEAT CUSHION

Step 1

If Buckle Pad is installed, grasp top of Buckle Pad and pull up to remove from Buckle.

Unfasten the locking tabs at the lower front edge of the Seat Cushion.

Step 2

Grasp Seat Cushion at the bottom front edge, then lift and pull forward as shown in **Figure 135**. Once the Seat Cushion releases, pull the Buckle through the Seat Cushion.

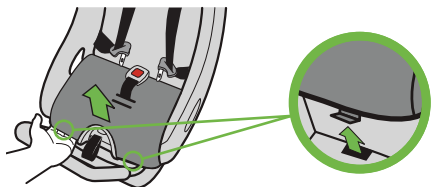

Figure 135

TO INSTALL SEAT CUSHION

Step 1

Insert the Buckle through the slot in the Seat Cushion that matches the slot the Crotch Strap is through in the seat.

Step 2

Insert the tabs on the back of the Seat Cushion through the slots in the Crumb Catcher (if applicable) and the pad and into the seat back at the back of the seat bottom.

Push the locking tabs at the lower front of the Seat Cushion into the holes at the front edge of the seat as shown in **Figure 136**.

Step 3

Grasp Buckle and push through opening in Buckle Pad to install Buckle Pad.

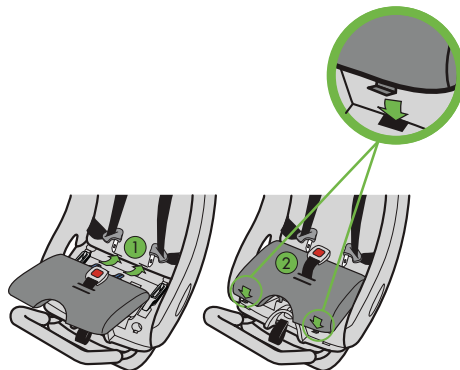

Figure 136

Installing/Removing Anti-Rebound Bar

TO INSTALL ANTI-REBOUND BAR

Step 1

With Rear-Facing Base installed, fully recline the seat to Recline Position 3 by pulling Recline Handle out and rotating car seat back as shown in **Figure 137**.

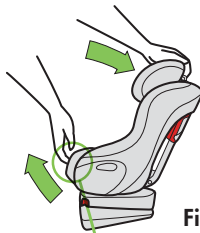

Figure 137



Step 2

Remove Seat Cushion, see “Removing/Installing Seat Cushion” on page 82.

If your seat has a Crumb Catcher, as shown in **Figure 138a**, unzip each zipper (1), then lift the Crumb Catcher up (2), pulling the Crotch Strap out of the Crumb Catcher (3) as shown in **Figure 138b**.

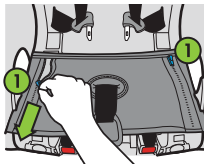

Figure 138a

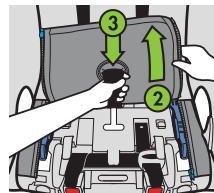

Figure 138b

NOTE: If your seat has a Crumb Catcher, it may be held out of the way by positioning it behind the harness straps, as shown in **Figure 139**.

Remove Rear-Facing LATCH Connectors from their storage location, see “Rear-Facing LATCH Storage” on page 87.

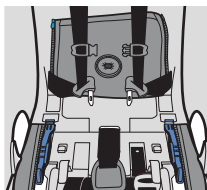

Figure 139

Step 3

Insert the Anti-Rebound Bar into the holes in the bottom of the seat in front of the base as shown in **Figure 140**.

Step 4

Hold the Anti-Rebound Bar in place and insert Locking Pins into the holes in the seat and through the Anti-Rebound Bar as shown in **Figure 141**. Check that each Locking Pin is securely installed through both sides of the Anti-Rebound Bar and that the Locking Pin Clips are through the Locking Pins.

Step 5

If installing with vehicle belt, place Rear-Facing LATCH Connectors back into their storage location, see “Rear-Facing LATCH Storage” on page 87.

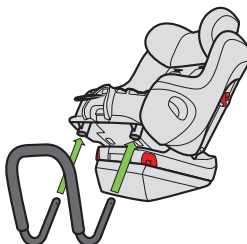

Figure 140

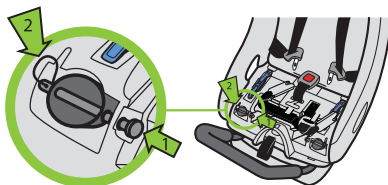

Figure 141

TO REMOVE ANTI-REBOUND BAR

Step 1

Remove the Seat Cushion, see “Removing/Installing Seat Cushion” on page 82.

If your seat has a Crumb Catcher, as shown in **Figure 142a**, unzip each zipper (1), then lift the Crumb Catcher up (2), pulling the Crotch Strap out of the Crumb Catcher (3) as shown in **Figure 142b**.

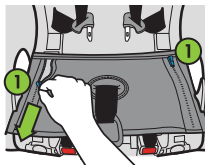

Figure 142a

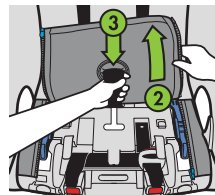

Figure 142b

If LATCH Connectors are stored, remove them from their storage location, see “Rear-Facing LATCH Storage” on page 87.

Step 2

Remove the Locking Pins and Locking Pin Clips from the seat as shown in **Figure 143**. The Anti-Rebound Bar should slide down until it comes completely out of the seat.

NOTE: Seat must be in Recline Position 3 to allow the Anti-Rebound bar to be removed.

Step 3

Keep Locking Pins and Locking Pin Clips with Anti-Rebound Bar for storage.

Step 4

Place LATCH Connectors back into their storage location, see “Rear-Facing LATCH Storage” on page 87.

If your seat has a Crumb Catcher, insert Crotch Strap through Crotch Strap Opening, as shown in **Figure 144a**, then pull Crumb Catcher down into place and secure each zipper, as shown in **Figure 144b**.

Install the Seat Cushion, see “Removing/Installing Seat Cushion” on page 82.

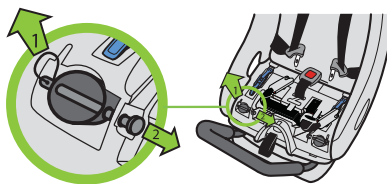

Figure 143

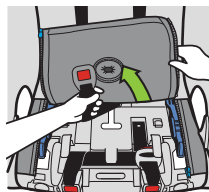

Figure 144a

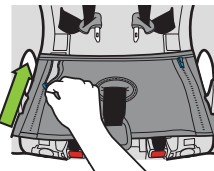

Figure 144b

Rear-Facing LATCH Storage

REMOVAL OF LATCH FROM STORAGE

Step 1

Remove the Seat Cushion, see “Removing/Installing Seat Cushion” on page 82.

If your seat has a Crumb Catcher, as shown in **Figure 145a**, unzip each zipper (1), then lift the Crumb Catcher up (2), pulling the Crotch Strap out of the Crumb Catcher (3) as shown in **Figure 145b**.

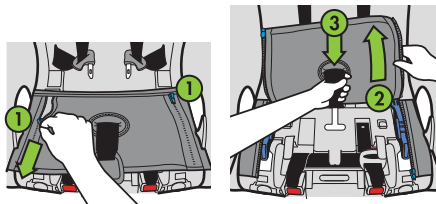

Figure 145a

Figure 145b

Step 2

Remove the Rear-Facing LATCH Adjuster (1) and Belt (2) from their storage position in the seat bottom shown in **Figure 146**.

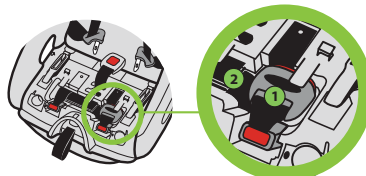

Figure 146

Step 3

Push and hold red release button on Rear-Facing LATCH Connectors and pull out as shown in **Figure 147**.

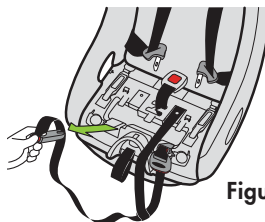

Figure 147

STORAGE OF REAR-FACING LATCH

Step 1

Remove the Seat Cushion, see “Removing/Installing Seat Cushion” on page 82.

If your seat has a Crumb Catcher, as shown in **Figure 148a**, unzip each zipper (1), then lift the Crumb Catcher up (2), pulling the Crotch Strap out of the Crumb Catcher (3) as shown in **Figure 148b**.

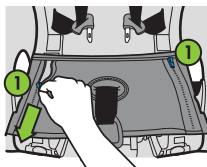

Figure 148a

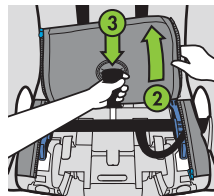

Figure 148b

Step 2

Place LATCH Connectors in seating area by inserting through Rear-Facing Belt Path.

Step 3

Insert the Rear-Facing LATCH Connectors, with the slots in the end oriented toward the outside of the seat, into the openings at the front of the seat bottom. As shown in **Figure 149**.

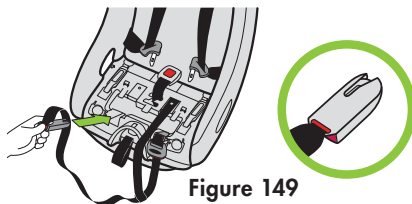

Figure 149

Step 4

Insert the Rear-Facing LATCH Adjuster (1) into the square recess behind the LATCH Connectors, fold the excess Rear-Facing LATCH Belt (2) and insert under tab as shown in **Figure 150**.

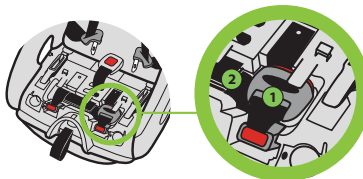

Figure 150

Step 5

If your seat has a Crumb Catcher, insert Crotch Strap through Crotch Strap Opening, as shown in **Figure 151a**, then pull Crumb Catcher down into place and secure each zipper, as shown in **Figure 151b**.

Install the Seat Cushion, see “Removing/Installing Seat Cushion” on page 82.

Forward-Facing Rigid LATCH Storage

To store the Rigid LATCH Connectors, pull and hold the Rigid LATCH Adjustment Handle while pulling the Rigid LATCH Connectors into the seat until they stop as shown in **Figure 152**.

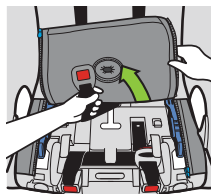

Figure 151a

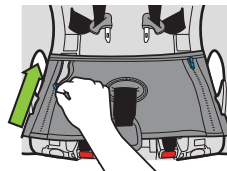

Figure 151b

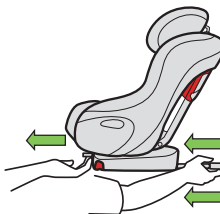

Figure 152

Top Tether Storage

Removal: Remove Instruction Manual and Tether belt from back of seat. Pull in and hold retention spring on Tether Hook, then remove hook from storage bar as shown in **Figure 153**, then replace Instruction Manual.

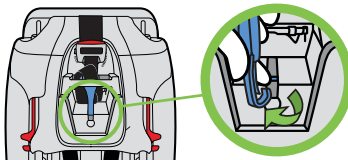

Figure 153

Storage: Remove Instruction Manual from back of seat. Hook Tether Hook around storage bar as shown in **Figure 154**, fold Top Tether belt and insert into Tether Storage. Replace Instruction Manual.

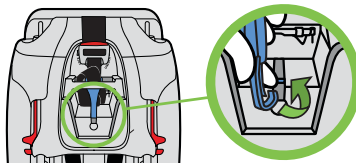

Figure 154

Instruction Manual Storage

After carefully reading and following these instructions, keep this manual for future use and store in the compartment located in Shoulder Harness Access Panel, as shown in **Figure 155**.

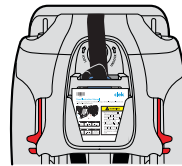

Figure 155

Aircraft Installation

Clek strongly recommends that children are secured in their child seat during airline travel.

FORWARD-FACING

To install this car seat in an aircraft Forward-Facing, follow the instructions for installing the car seat with a lap belt in the “Installing Forward-Facing Car Seat With Vehicle Belt” on page 66.

IMPORTANT: Aircraft are not equipped with top tether anchors. The Top Tether should be stored in the back of the car seat and not used on an aircraft, see “Top Tether Storage” on page 89.

REAR-FACING

To install this car seat in an aircraft Rear-Facing, follow the instructions for installing the car seat with a lap belt in the “Installing Rear-Facing Car Seat With Vehicle Belt” on page 46.

IMPORTANT: The Rear-Facing Base and Anti-Rebound Bar must be used when installing this car seat Rear-Facing in an aircraft.

NOTE: If it is necessary to check your seat, it must be packed in a Clek Weelee Travel Bag (sold separately). Damage may result from checking your seat without proper packaging.

Care and Cleaning

Removing/Installing Seat Cushion Cover

TO REMOVE SEAT CUSHION COVER

Step 1

Remove the Seat Cushion from the Seat, see “Removing/Installing Seat Cushion” on page 82.

Step 2

Turn Seat Cushion over to locate the Seat Cushion Cover attachments, as shown in **Figure 156**.

Step 3

Using your thumb, push inward on each Seat Cushion Cover attachment one at a time to release the Cover from the Seat Cushion, as shown in **Figure 157**.

Step 4

Remove Seat Cushion Cover from Seat Cushion, as shown in **Figure 158**.

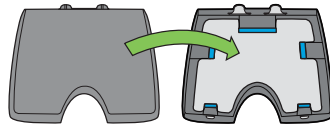

Figure 156

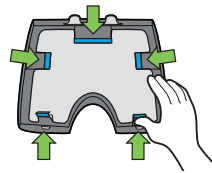

Figure 157

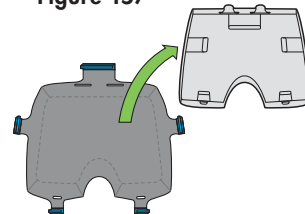

Figure 158

TO INSTALL SEAT CUSHION COVER

Step 1

Place Seat Cushion Cover on a flat surface with Seat Cushion Cover attachments facing up, as shown in **Figure 159**.

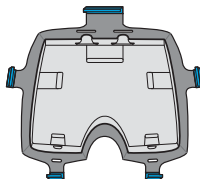

Figure 159

Step 2

Place Seat Cushion onto Seat Cushion Cover, aligning the Seat Cushion with the Seat Cushion Cover attachments.

Step 3

Reattach Seat Cushion Cover attachments to Seat Cushion by wrapping the Seat Cushion Cover sides around the entire Seat Cushion, as shown in **Figure 160**.

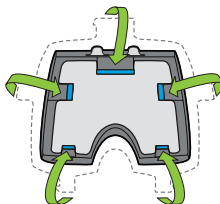

Figure 160

Step 4

Install Seat Cushion, see "Removing/Installing Seat Cushion" on page 82.

SEAT BACK COVER REMOVAL/INSTALLATION

Removal of the seat back cover is not recommended unless necessary due to heavy soiling which cannot be removed by surface washing. For instructions on removal and installation of the seat back cover go to: www.clekinc.com/cover-instructions-foof

Car Seat Cleaning

FABRIC CARE INSTRUCTIONS

Step 1

If the spot has dried, try lightly brushing or scraping off the residue. Wipe surface with water.

Step 2

If a spot still remains, apply a mild detergent to fabric with a light mist.

Step 3

Work area using soft brush or edge of spoon from outside of spot towards the middle.

Step 4

Allow solution to work for approximately one minute.

Step 5

Remove with clean water or blot with clean soft towel.

Step 6

Repeat steps 3-5 as necessary until spot is removed.

Step 7

Rinse with clear lukewarm water and blot with clean soft white cloth as final step.

SEAT FRAME (EXTERIOR PLASTICS ONLY) WASHING INSTRUCTIONS

Use a soft cloth with warm water and soap. Apply light pressure with cloth in small circular motions.

Do NOT remove the labels from this car seat. They are meant to be permanent so they can remind you and others of important information. Removal will marr the finish of the seat.

HARNESS CARE INSTRUCTIONS

Surface wash straps with a damp cloth using warm water and a mild detergent.

BUCKLE WASHING INSTRUCTIONS

Buckle may be rinsed under warm water. Do not use detergents or lubricants.

RECYCLING YOUR CAR SEAT

For instructions on how to recycle your Clek Foonf child seat, please visit:
www.clekinc.com/recycle

Troubleshooting

For instructions on troubleshooting your Clek Foonf child seat, please visit:
www.clekinc.com/support/foonf

Accessories

Optional accessories for this product may be purchased at: www.clekinc.com/accessories

Warranty

LIMITED WARRANTY

Clek Inc. warrants, only to the original consumer purchaser and only if this product was purchased (new and unused in an unopened box) from an authorized Clek retailer listed at www.clekinc.com, that this product will be free from defects in material and workmanship for one (1) year from the date of original purchase (the “Warranty Period”). During the Warranty Period, Clek Inc. will, at its option, repair or replace this product if it is found by the manufacturer to be defective in material or workmanship. Clek Inc. reserves the right to discontinue or change parts, fabrics, models, or products, or to substitute this product with a comparable model or product. To make a claim under this warranty, please contact us at http://www.clekinc.com/contact_us/, call us at 1-866-656-2462, or write to us at Clek Inc., Attn: Customer Service, Clek Inc., 226 Lesmill Road, Toronto, Ontario, Canada M3B 2T5. An original receipt is required to validate your warranty and shipping charges will be the responsibility of the original consumer purchaser. To expedite the processing of any future warranty claims and to verify the original date of purchase, please complete and mail the pre-addressed owner registration card within thirty (30) days of purchase.

WARRANTY LIMITATIONS

This warranty does not cover the effects of normal wear and tear or damage resulting from negligence, modification, improper installation, accidents, misuse or abuse of this product. It is expressly agreed that the obligations of Clek Inc. and the original consumer purchaser’s remedies under the limited warranty contained herein are exclusive and are strictly limited to the repair or replacement of the product. This limited warranty is conditional upon strict compliance with the provisions of the Instruction Manual. In no event will Clek Inc. or the dealer selling this product be liable to you for any damages, including incidental or consequential damages, arising out of the use or inability to use this product.

LIMITATION OF WARRANTIES AND STATE/PROVINCIAL LAW RIGHTS

The warranty and remedies as set forth above are exclusive and in lieu of all others, oral or written, express or implied. To the extent permitted by applicable law, any implied warranties, including implied warranties of merchantability and fitness for a particular purpose, are hereby disclaimed. Some states/provinces DO NOT allow limitations as to how long an implied warranty lasts or the exclusion or limitation of incidental or consequential damages, so the above limitations may not apply to you. This warranty gives you specific legal rights, and you may have other rights, which vary from state/province to state/province. Neither Clek Inc. nor the dealer selling this product has authorized any person to create for it any other warranty, obligation, or liability in connection with this product.

How To Receive Spanish Instructions

This instruction manual is also available in Spanish. To request a copy to be sent to you free of charge, please contact Clek Customer Service at 1-866-656-2462 or email us at customerservice@clekinc.com. You can also download a copy of the Foofn instruction manual in Spanish online at www.clekinc.com/support/foofn/videos-and-manuals

Cómo recibir las instrucciones en español

Este manual de instrucciones también está disponible en español. Para pedir que se le envíe una copia sin cargo alguno, tenga a bien ponerse en contacto con el servicio al cliente de Clek, para lo cual llame al 1-866-656-2462 o envíe un mensaje de correo electrónico a customerservice@clekinc.com. También puede descargar una copia del manual de instrucciones de Foofn en español por Internet en www.clekinc.com/support/foofn/videos-and-manuals

Keep this Instruction Manual for future use.
Store in Shoulder Harness Access Panel on back of this car seat.

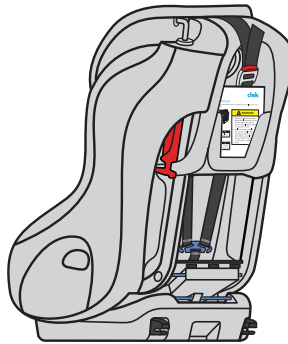

www.clekinc.com

Clek Inc.
226 Lesmill Road
Toronto, Ontario Canada
M3B 2T5
1-866-656-2462