



OL21USA3

dek

Olli and Ozzi Instruction Manual

This belt-positioning booster seat (booster seat) is designed for use by children who meet these requirements:

HEIGHT	WEIGHT	MINIMUM AGE
40–57 in. 101–145 cm	40–120 lb 18–54 kg	4+ years



WARNING

- Read and understand all information and instructions on product labels and in this manual and in your vehicle owner's manual before installing or using this booster seat.
- The child's safety depends on you correctly installing and using this booster seat. Failure to properly install or use this booster seat increases the risk of serious injury or death to the child and others in a sharp turn, sudden stop or crash.

Checklist for Proper Use

For proper use read and understand all instructions and booster seat labels.

- ✓ Child weighs between 40 and 120 lb (18 and 54 kg) height is between 40 and 57 in. (101 and 145 cm)
- ✓ Child is at least 4 years of age
- ✓ Child is sitting in the booster seat in a forward facing seating position in a rear seat of the vehicle
- ✓ The tops of the child's ears are below the top of the vehicle seat back or the vehicle seat's fully deployed headrest
- ✓ Shoulder belt crosses midpoint of the child's chest and is not twisted
- ✓ Belt is routed correctly beneath armrests and sits low and snug on the child's hips and is not twisted
- ✓ There is no slack in the shoulder belt
- ✓ Child is sitting upright and is not slouching
- ✓ Booster seat is securely installed with both LATCH connectors attached to LATCH lower anchors, if available

Table of Contents

General Information	2
Booster Seat Features	3
Registration and Recall Information	4
Registering Your Booster Seat.....	5
Warnings	6
Certification	9
Height & Weight Limitations	9
American Academy of Pediatrics (AAP) Recommendations	10
Vehicle Requirements	11
LATCH Anchorage System	11
Vehicle Seat Location Requirements	12
Vehicle Seat Belt Requirements	14
Installing/Removing Booster Seat in Vehicle	16
Installing Booster Seat in Vehicle Using LATCH Connectors	17
Installing Booster Seat in Vehicle Without Using LATCH Connectors	20
Removing Booster Seat in Vehicle	21
Securing Child in Booster Seat	22
Care & Cleaning	27
Service & Accessories	31
Warranty	31
Limited Warranty	31
Warranty Limitations	32
Limitation of Warranties and State/Provincial Law Rights	32
How to Receive Spanish Instructions	33
Cómo recibir las instrucciones en español	33
Owner's Manual Storage	34

General Information

clek

Designed for kids... Engineered for parents

Safety Features:

- Raises your child 4 in. (10 cm) to improve in-vehicle shoulder belt fit
- Better positions the belt on the child's hips to improve safety
- Confirms that LATCH Connectors are locked with an audible "click"
- Provides a secure, rigid LATCH attachment to the vehicle's seat structure

Convenience:

- Easy installation and removal of booster seat
- Removable and washable seat cover
- Ultra light for easy portability between vehicles

Style/Comfort:

- Plush seating surface
- Engineered energy absorbing comfort-cube construction for added comfort
- Optional seat covers available

For concerns related to the parts, use or maintenance of this product, please contact us at:

Clek Inc.
226 Lesmill Road
Toronto, Ontario, Canada
M3B 2T5
1-866-656-2462
www.clekinc.com

Booster Seat Features

- 1 LATCH connectors
- 2 Belt-routing surface
- 3 Armrests
- 4 comfort-cube
- 5 Quick Release System*
- 6 Removable & washable seat cover
- 7 drink-thingy*
- 8 Manual Release System

* (olli model only)

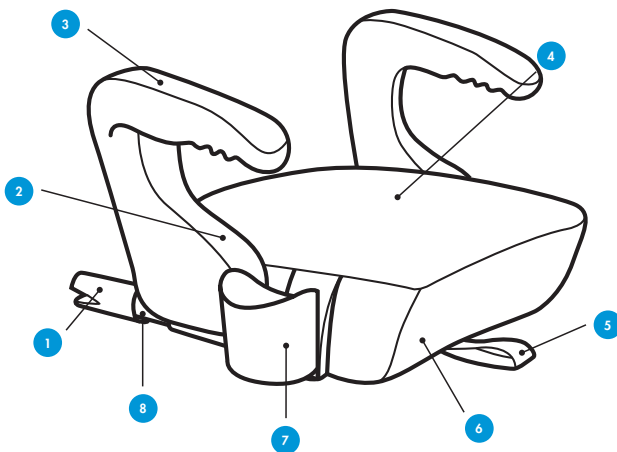

Registration and Recall Information



WARNING

Child restraints could be recalled for safety reasons. You must register this restraint to be reached in a recall.

Model Name: _____

Serial Number: _____

Manufactured in: _____
(yyyy/mm/dd)

Date of Purchase: _____

Registering Your Booster Seat

Please fill in the information on page four for your records. The model name, serial number and manufacturing date can be found on a label affixed to the underside of the booster seat frame, as shown in **Figure 1**.

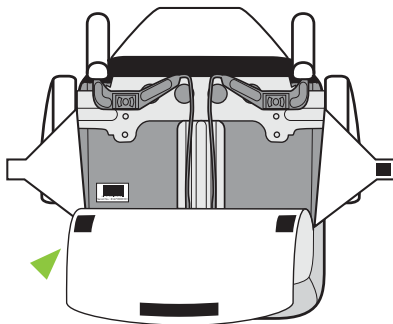

Figure 1

Fill out the prepaid registration postcard attached to the seat and mail it today.

Child restraints could be recalled for safety reasons. You must register this restraint to be reached in a recall. Send your name, address, email address if available, and the restraint's model number and manufacturing date to:

Clek Inc.
226 Lesmill Road
Toronto, Ontario, Canada, M3B 2T5

or call 1-866-656-2462

or register online at: www.clekinc.com/register

For recall information, call the U.S. Government's Vehicle Safety Hotline at 1-888-327-4236 (TTY: 1-800-424-9153), or go to: www.NHTSA.gov

Warnings



WARNING

Failure to properly use this booster seat or follow these warnings and instructions and those on this booster seat's labels can result in serious injury or death of the child in a sharp turn, sudden stop or crash. Please read and follow all booster seat and vehicle instructions carefully.

- Do not install or use this booster seat until you read and understand the instructions in this manual and in your vehicle owner's manual. Do not let others install or use this booster seat unless they understand how to correctly install and use it.
- The child's safety depends on you correctly installing and using this booster seat. Failure to properly install or use this booster seat increases the risk of serious injury or death to the child and others in a sharp turn, sudden stop or crash.
- To avoid injury, this booster seat must be installed by an adult. NEVER allow the child to buckle themselves in this booster seat.
- Only use this booster seat with children who weigh between 40–120 lb (18–54 kg) and whose height is between 40–57 in. (101–145 cm). Using this booster seat with a child who does not meet these requirements will increase the risk of serious injury or death to the child.
- Do not use this booster seat after an accident of any kind. An accident can cause damage to the booster seat that you cannot see.
- Do not use this booster seat if the tops of the child's ears are above the top of the vehicle seat back or a fully deployed head restraint on the vehicle seat. Severe head or neck injuries could result without proper head support.



WARNING

- NEVER use a seat belt extender with this booster seat.
- **WARNING!** Use only the vehicle's lap and shoulder belt system when restraining the child in this booster seat. You must properly route the seat belt underneath the armrests on this booster seat. Do not use this booster seat with motorized, door mounted, or lap-only belt systems.
- According to accident statistics, children are safer when properly restrained in rear vehicle seating positions, rather than front seating positions. Before using this booster seat please reference your vehicle owner's manual for information about air bags and booster seat use. NEVER use this booster seat in a front vehicle seat location unless recommended by your vehicle owner's manual.
- Install this booster seat only on vehicle seats that face forward. Do not install this booster seat on vehicle seats facing sideways or backwards.
- ALWAYS secure this booster seat to the vehicle's LATCH anchorage system if available. This booster seat may still be used in vehicles or rear seat positions without a LATCH anchorage system provided the booster seat is properly positioned on the vehicle seat and the child and the booster seat are properly secured using the vehicle's seat belts.
- Do not use this booster seat in a seating position where the seat belt buckle is not easily accessible with the booster seat latched in place.
- NEVER leave this booster seat unsecured in your vehicle. This booster seat must remain connected to the LATCH lower anchors in the vehicle or secured by the vehicle's seat belt even when not in use. In a sharp turn, crash or sudden stop, an unsecured booster seat can be thrown around and could severely injure vehicle occupants.



WARNING

- NEVER leave the child unattended. NEVER take the child out of the booster seat or try to tend to the child's needs while the vehicle is moving.
- NEVER allow any child to play with this booster seat.
- Do not use this booster seat after nine (9) years from the date of manufacture. The date of manufacture can be found on the label affixed to the underside of the booster seat frame.
- Do not attempt to make repairs to or otherwise modify or tamper with this booster seat. For instructions on proper removal of the seat cover, see section titled "Care & Cleaning."
- NEVER use this booster seat if it has damaged or missing parts. Do not use a cut, damaged, frayed or inoperable vehicle seat belt.
- Do not use accessories or parts with this booster seat other than those provided by Clek Inc. Use of accessories or parts from other manufacturers could alter the performance of the booster seat.
- This booster seat can become very hot if left in the sun and can burn the child's skin. ALWAYS touch the surfaces of the parts first before putting the child in the booster seat.
- Keep this manual in the storage pouch located on the bottom of the booster seat for future use.
- NEVER use a second-hand booster seat or a booster seat whose history you do not know.
- Register your booster seat with Clek Inc.



WARNING

- To avoid injury, the child must remain buckled with the vehicle lap and shoulder belt properly positioned and snugly adjusted on child. If the child is unable to remain still enough to keep the belt properly positioned, they should be moved to a properly fitting harness seat.

Certification

- This booster seat conforms to all applicable Federal Motor Vehicle Safety Standards and is certified for use in motor vehicles
- **This restraint is not certified for aircraft use because aircraft seats do not have shoulder belts**

Height and Weight Limitations



WARNING

- Do not use this booster seat if the child does not meet all of the Child size requirements listed below. Using this booster seat with a child who does not meet these requirements will increase the risk of serious injury or death to the child.

American Academy of Pediatrics (AAP) Recommendation

The AAP advises parents to keep their children in a car seat with a harness for as long as possible, until they reach the maximum height and weight limit for their seat.

Children who have exceeded the limits of their harnessed car seat should use a booster seat until the vehicle's lap and shoulder seat belt fit properly.

The child **MUST** meet **ALL** of the following requirements to use this booster seat:

- Child's weight is between 40–120 lb (18–54 kg), and
- Child's height is between 40–57 in. (101–145 cm), and
- Child is at least 4 years of age, and
- The tops of the child's ears **MUST** be below the top of the vehicle seat back or a fully deployed headrest on the vehicle seat, below the **RED** zone as shown, and
- When sitting on the booster seat, the shoulder belt **MUST** lie snug across the mid point of the child's chest and across the **GREEN** zone as shown. The lap portion of the seat belt **MUST** be positioned low and snug on the child's hips. See section titled "Securing Child in Booster Seat."

HEIGHT	WEIGHT	MINIMUM AGE
40–57 in. 101–145 cm	40–120 lb 18–54 kg	4+ years

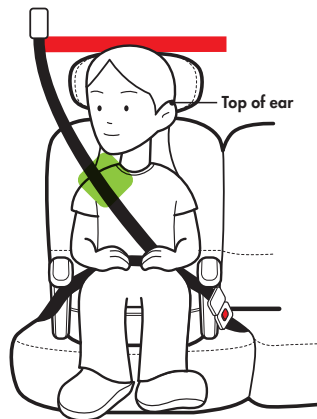

Vehicle Requirements

LATCH Anchorage System

(applicable only if installing booster seat in vehicle using LATCH connectors)

- LATCH stands for Lower Anchors and Tethers for Children, also referred to as lower Universal Anchorage System (UAS). The term refers to the pair of fixed lower anchors built into the crease between the seat back and seat cushion. The **clek** booster seat has been designed to attach securely to the vehicle's LATCH lower anchors.
- 2003 model year vehicles or newer have LATCH anchorage systems. Some 2001 & 2002 model year vehicles have LATCH anchorage systems. 2000 model year vehicles or older do not have LATCH anchorage systems. See your vehicle owner's manual or the "Vehicle LATCH Availability Chart" in the index of this manual if you are unsure if your vehicle is equipped with a LATCH anchorage system.
- The LATCH lower anchors are located in the crease between the seat back and seat cushion, as shown in **Figure 2**.
- If not readily visible, the LATCH lower anchors may be noted by a symbol located near the crease between the seat back and seat cushion, as shown in **Figure 3**.

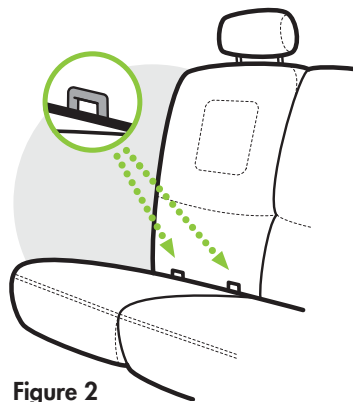

Figure 2

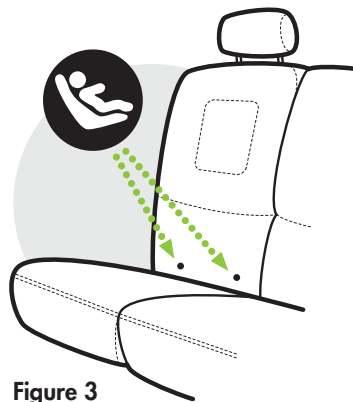

Figure 3

Vehicle Seat Location Requirements

WARNING

Improper placement of the booster seat in your vehicle increases the risk of serious injury or death. Some seating positions in your vehicle may not be safe for this booster seat. Some vehicles do not have any seating positions that can be used safely with the booster seat. If you are not sure where to place the booster seat in your vehicle, consult your vehicle owner's manual or call 1-866-656-2462.

- According to accident statistics, children are safer when properly restrained in rear vehicle seating positions, rather than front seating positions, as shown in **Figure 4**. NEVER use this booster seat in a front vehicle seat location unless recommended by your vehicle owner's manual. Whenever possible secure the booster seat in the center position of the seat directly behind the front seats. However, this position is often equipped with a lap belt only and cannot be used with this booster seat.



Figure 4

- Install this booster seat only on vehicle seats that face forward. DO NOT install this booster seat on vehicle seats facing sideways or backwards, as shown in **Figure 5**.



Figure 5

- Only use the booster seat on vehicle seats with seat backs that lock in an upright position. Check that the seat back is locked.

Vehicle Seat Belt Requirements

WARNING

- Many seat belt systems are not safe to use with this booster seat. Pay careful attention to these systems; some of the seat belts that are not safe to use look very much like seat belts that are safe to use. If you are unsure, consult your vehicle owner's manual or call 1-866-656-2462.
- NEVER use this booster seat if it has damaged or missing parts. Do not use a cut, damaged, frayed or inoperable vehicle seat belt.
- Use only the vehicle's lap and shoulder belt system when restraining the child in this booster seat, as shown in **Figure 6**.

- Design and operation of vehicle seat belt systems vary from vehicle to vehicle and from seating location to seating location in the same vehicle. Refer to your vehicle owner's manual for proper use, placement and adjustment of the vehicle's lap and shoulder belts.

SAFE VEHICLE SEAT BELT SYSTEMS

- Use **ONLY** the vehicle's lap and shoulder belt system when restraining the child in this booster seat, as shown in **Figure 6**.

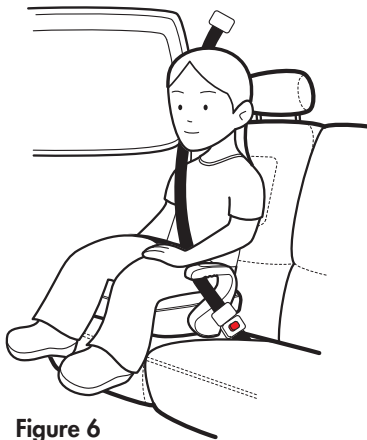

Figure 6



WARNING

- NEVER use a lap-only belt. Use with a lap-only belt could result in serious injury or death to the child, as shown in **Figure 7a**.
- NEVER use a passive restraint – lap or shoulder belt mounted on door, as shown in **Figure 7b**.
- NEVER use a passive restraint – lap belt with motorized shoulder belt, as shown in **Figure 7c**.
- NEVER use vehicle belts that are attached to the door in any way or that move along a track to automatically surround the passenger when the door is closed, as shown in **Figures 7b and 7c**.

UNSAFE VEHICLE SEAT BELT SYSTEMS



Figure 7a



Figure 7b

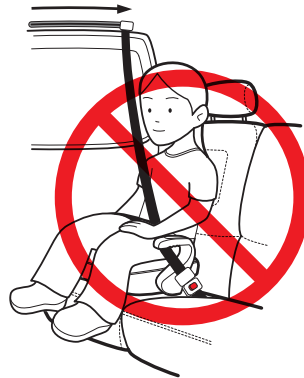

Figure 7c

Installing/Removing Booster Seat in Vehicle



WARNING

- The child's safety depends on you correctly installing and using this booster seat. Failure to properly install or use this booster seat increases the risk of serious injury or death to the child and others in a sharp turn, sudden stop or crash.
- This booster seat is designed to be used with the vehicle's LATCH anchorage system. ALWAYS secure this booster seat to the vehicle's LATCH anchorage system if available. This booster seat may still be used in vehicles or rear seat positions without a LATCH anchorage system provided the booster seat is properly positioned on the vehicle seat and the child and the booster seat are properly secured using the vehicle's seat belts.
- To avoid injury this booster seat must be installed by an adult.

Installing Booster Seat in Vehicle using LATCH connectors

Step 1

Select a forward facing vehicle position which has a lap and shoulder belt. Locate the LATCH lower anchors (as explained in the "LATCH Anchorage System" section of this manual or refer to your vehicle owner's manual), as shown in **Figures 8** and **9**.

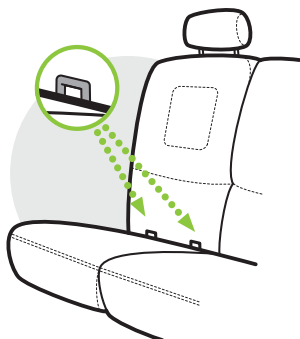

Figure 8

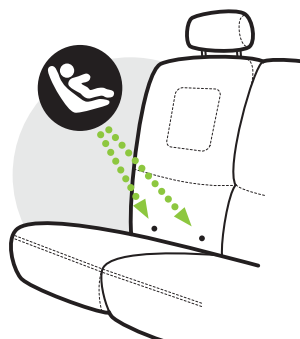

Figure 9

Step 2

Line up the LATCH connectors of the booster seat with the LATCH lower anchors on the vehicle seat, as shown in **Figures 10** and **11**.

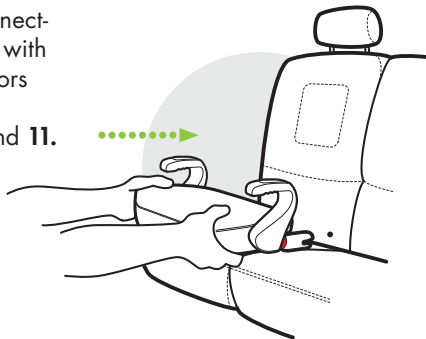

Figure 10

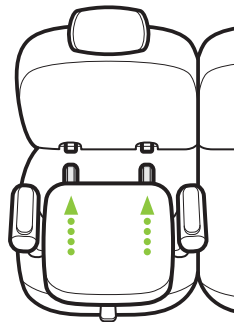

Figure 11

Step 3

Press the LATCH connectors against the LATCH lower anchors until you hear each LATCH connector click, as shown in **Figures 12** and **13**.



Figure 12

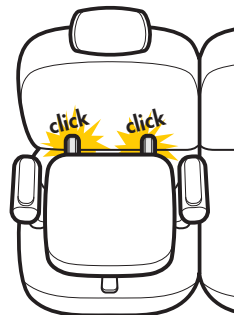

Figure 13

If LATCH connectors fail to connect to the LATCH lower anchors, you can still use this seat by securing the vehicle seat belt underneath the armrests. See section titled "Installing Booster Seat in Vehicle Without Using LATCH Connectors". However, please notify us if the connectors fail to latch by calling 1-866-656-2462.

Step 4

Once the LATCH connectors are fully connected to the LATCH lower anchors, pull forward on the booster seat to make sure it is securely attached, as shown in **Figure 14**. If not, start over at **Step 1**.

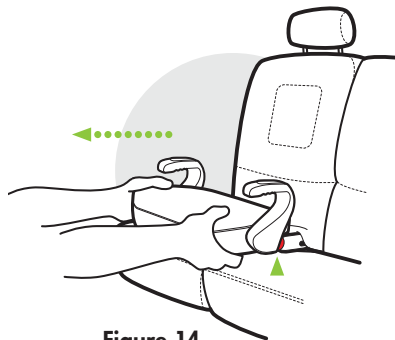

Figure 14

 **WARNING**

Do not secure this booster seat to the vehicle's LATCH anchorage system if the seat belt or seat belt buckle is not easily accessible with the booster seat latched in place or if either of the following conditions exist, as shown in **Figures 15a** and **15b**.



Figure 15a

Seat belt buckle is located in between LATCH anchors

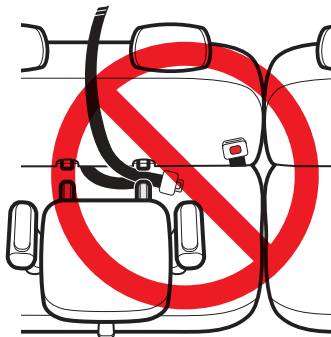

Figure 15b

Seat belt is located in between LATCH anchors

Installing Booster Seat in Vehicle without using LATCH connectors

Step 1

Select a forward facing vehicle position which has a lap and shoulder belt. Position the booster seat firmly against seat back with LATCH connectors tucked into the crease between the seat back and seat cushion, as shown in **Figures 16** and **17**.



Figure 16

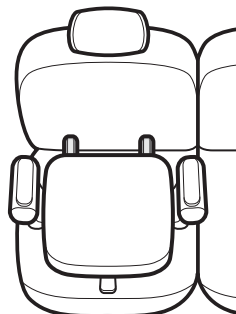

Figure 17



WARNING

NEVER leave this booster seat unsecured in your vehicle. This booster seat must remain connected to the LATCH lower anchors in the vehicle or secured by the vehicle's seat belt even when not in use. In a sharp turn, crash or sudden stop, an unsecured booster seat can be thrown around and could severely injure vehicle occupants.

Removing Booster Seat in Vehicle

MANUAL RELEASE

Locate the red buttons on the front of the LATCH connectors.

Releasing one LATCH connector at a time, use your thumb to press in on one button while using the other hand to pull the booster seat forward, as shown in **Figure 18**. Repeat for the other LATCH connector.

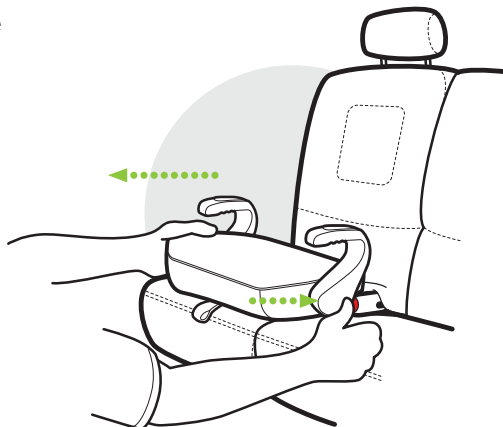

Figure 18

QUICK RELEASE

(**olli** model only)

Locate the release strap hanging at the front of the seat.

Place one hand **FIRMLY** on the front edge of the booster seat. Use the other hand to pull forward on the strap releasing both LATCH connectors and pulling the booster seat forward, as shown in **Figure 19**.

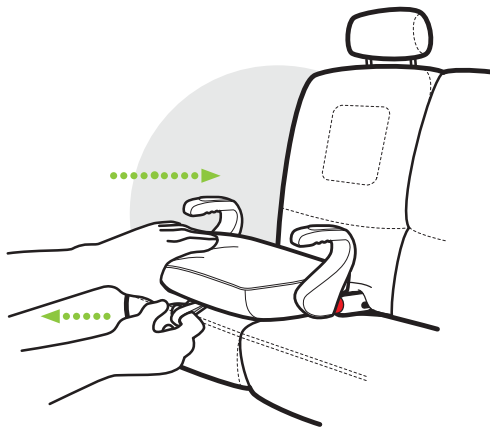

Figure 19

Securing Child in Booster Seat

WARNING

- Only use this booster seat with children who weigh between 40–120 lb (18–54 kg) and whose height is between 40–57 in. (101–145 cm).
- To avoid injury, the child must be secured by an adult. NEVER allow the child to buckle themselves in this booster seat.
- This booster seat can become very hot if left in the sun and could burn the child's skin. ALWAYS touch the surfaces of the parts first before putting the child in the booster seat.

Step 1

If the vehicle seat back is adjustable, make sure the seat back is in the upright position. DO NOT allow the child to sit in booster seat while the vehicle seat is reclined, as shown in **Figure 20**.

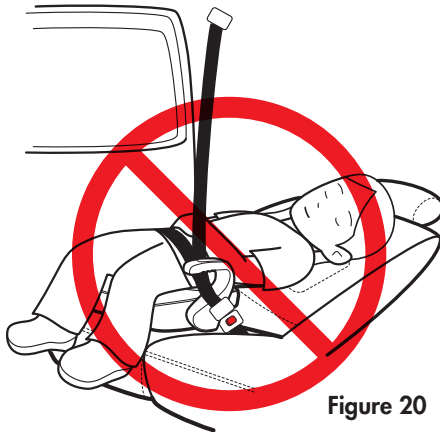

Figure 20

Step 2

The child **MUST** sit in the booster seat with their back flat against the vehicle seat back. The tops of the child's ears **MUST** be below the top of the vehicle seat back or a fully deployed head restraint on the vehicle seat, as shown in **Figure 21**. Severe head or neck injuries could result without proper head support.



Figure 21

Step 3

Position the lap belt underneath the outboard armrest, as shown in **Figure 22**. **DO NOT** position any part of the vehicle seat belt over the top of the armrest or behind the armrest.

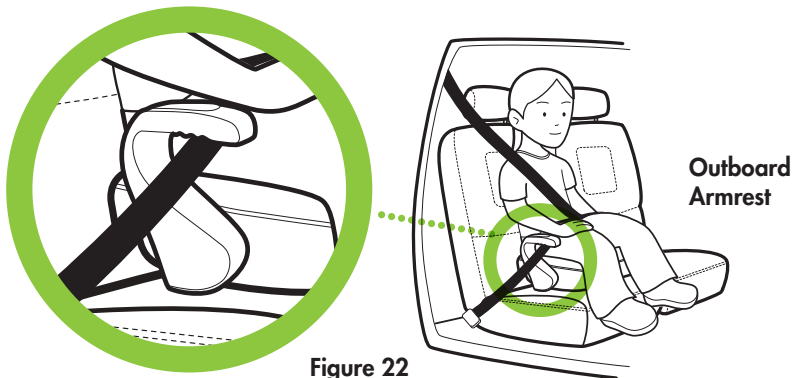

Figure 22

Step 4

Pull the shoulder belt across the child's chest while positioning BOTH the lap and shoulder belt underneath the inboard armrest, as shown in **Figure 23**. Buckle the seat belt. Use only the vehicle's lap and shoulder belt system when restraining the child in this booster seat. NEVER use a vehicle lap-only belt system.

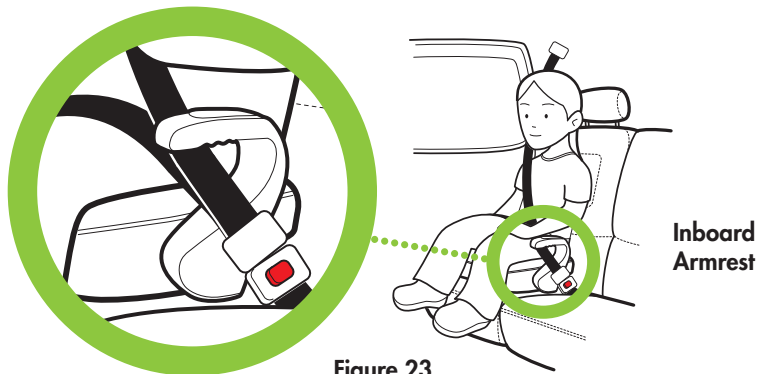

Figure 23



WARNING

- Do not secure this booster seat to the vehicle's LATCH anchorage system if the seat belt or seat belt buckle is not easily accessible with the booster seat latched in place (see figure 1 and Figure 2 on page 20).
- NEVER use a vehicle lap-only belt system (see Figure 1 on page 16).

Step 5

When sitting on the booster seat, the shoulder belt **MUST** lie snug across the mid point of the child's chest and across the **GREEN** zone, as shown in **Figure 24**.



Figure 24

Step 6

Vehicle seat belts **MUST** fit snug and lay flat against the child and **MUST** not be loose or twisted. A snug seat belt does not allow any slack. It lies in a relatively straight line without sagging. **DO NOT** position any part of the vehicle seat belt over the top of the armrest or behind the armrest, as shown in **Figure 25**.

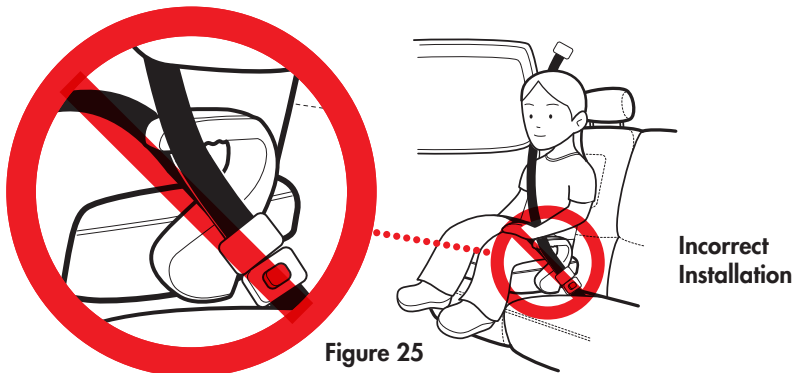

Figure 25

Step 7

The lap belt **MUST** sit low and snug on the child's hips. Pull on the shoulder belt to tighten. The shoulder belt **MUST** be centered over the child's shoulder and lie across the mid point of the child's chest.

WARNING

- Do not use with the shoulder belt touching the child's neck or face.
- Do not use with shoulder belt positioned under child's arm or behind the child, as shown in **Figures 26a** and **26b**.
- To avoid serious abdominal injury or death, a child **MUST** sit upright and not slouch in this booster seat, as shown in **Figure 26c**. If the child cannot maintain an upright position in this booster seat with their buttocks in contact with this booster Seat Cushion and their back in contact with the vehicle Seat Back, **DO NOT** use this booster seat.



Figure 26a



Figure 26b



Figure 26c

Care & Cleaning



WARNING

Do not use accessories or parts other than those provided by Clek Inc. use of accessories or parts from other manufacturers could alter the performance of the booster seat.

Removing Cover

1. Turn the seat so the bottom is facing up, as shown in **Figure 27**. Make sure the LATCH connectors are pointing toward your body.

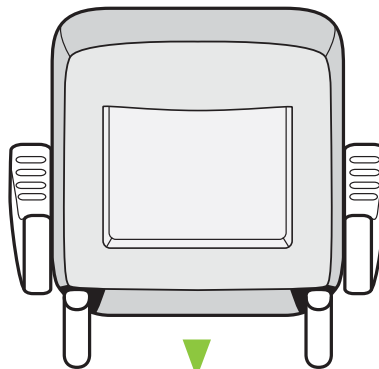

toward body

Figure 27

2. Pull up on the bottom flap and sides of the seat cover releasing the fastening strips. Flip the bottom flap forward so that it hangs in front of the seat, as shown in **Figure 28**.
3. Unfasten the triangular flaps and flip them sideways so that they hang off to the side of the seat, as shown in **Figure 28**.
4. Starting from the back, push down on the sides of the seat cushion cover, loosening the cover from the seat frame.

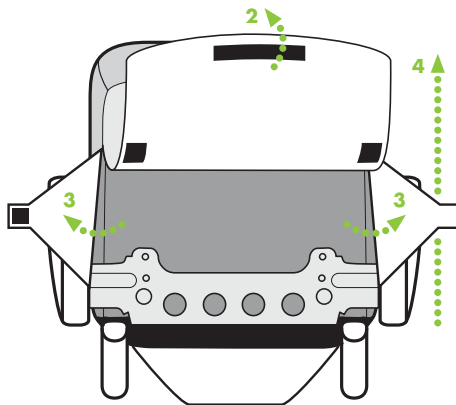

Figure 28

Washing Instructions

1. Once the seat cover is removed, set the foam pad aside. Do not wash foam pad.
2. Before washing, re-attach all fastening strips.
3. Machine wash separately: cold 80F/30 C, gentle cycle. DO NOT bleach. DO NOT iron. DO NOT dry-clean. Lay flat to dry.

Reinstalling Cover

1. Place the base frame right side up with the LATCH connectors pointing toward your body, as shown in **Figure 29**.
2. Place the foam pad on the frame, such that the underside grooves are aligned with the grooves in the seat frame.

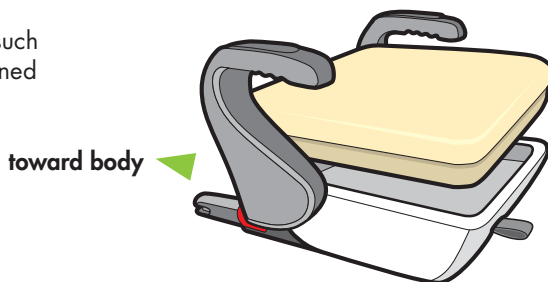

Figure 29

3. Unfasten the seat cover and align it with the seat frame.
4. Pull the cover over the frame, starting from the front of the seat (opposite LATCH connectors), as shown in **Figure 30**.

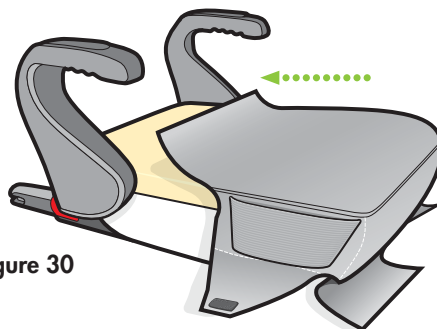
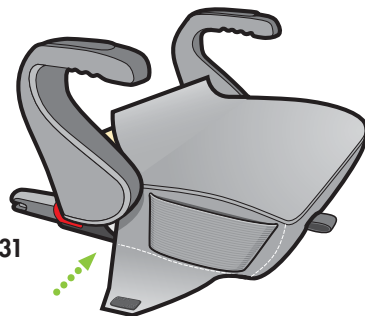

Figure 30

5. Tuck the seat cover inside the armrests, as shown in **Figure 31**.

Figure 31



6. Pull the cover over the back corners until it fits snug around the frame (Ensure that the foam pad has not shifted and that it sits properly on the frame), as shown in **Figure 32**.

Figure 32

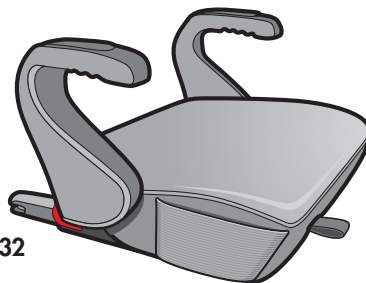

7. Turn the booster seat over so the bottom is facing up, as shown in **Figure 33**.
8. Re-attach triangular flaps at the fastening strip, as shown in **Figure 33**.
9. Pull on the bottom flap and re-attach fastening strip, as shown in **Figure 33**.

Figure 33

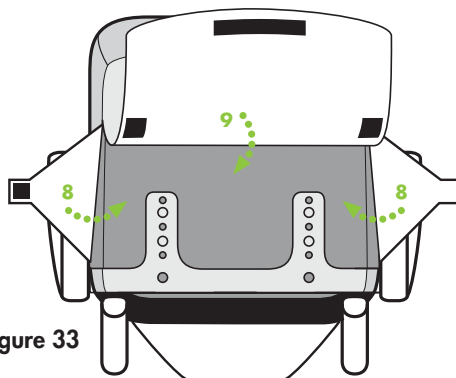

Service & Accessories

Optional trim covers & accessories for this product may be purchased at:
www.clekinc.com/accessories

Warranty

Limited Warranty

Clek Inc. warrants only to the original consumer purchaser and only if this product was purchased (new and unused in an unopened box) from an authorized Clek retailer listed at www.clekinc.com, that this product will be free from defects in material and workmanship for one (1) year from the date of original purchase (the "Warranty Period"). During the Warranty Period, Clek Inc. will, at its option, repair or replace this product if it is found by the manufacturer to be defective in material or workmanship. Clek Inc. reserves the right to discontinue or change parts, fabrics, models, or products, or to substitute this product with a comparable model or product. To make a claim under this warranty, please contact us at http://www.clekinc.com/contact_us/, call us at 1-866-656-2462, or write to us at Clek Inc., 226 Lesmill Road, Toronto, Ontario, Canada M3B 2T5. An original receipt is required to validate your warranty and shipping charges will be the responsibility of the original consumer purchaser. To expedite the processing of any future warranty claims and to verify the original date of purchase, please complete and mail the pre-addressed owner registration card within thirty (30) days of purchase.

Warranty Limitations

This warranty does not cover the effects of normal wear and tear or damages resulting from negligence, modification, improper installation, accidents, misuse or abuse of this product. It is expressly agreed that the obligations of Clek Inc. and the original consumer purchaser's remedies under the limited warranty contained herein are exclusive and are strictly limited to the repair or replacement of the product. This limited warranty is conditional upon strict compliance with the provisions of the owner's manual. In no event will Clek Inc. or the dealer selling this product be liable to you for any damages, including incidental or consequential damages, arising out of the use or inability to use this product.

Limitation of Warranties and State/Provincial Law Rights

The warranty and remedies as set forth above are exclusive and in lieu of all others, oral or written, express or implied. To the extent permitted by applicable law, any implied warranties, including implied warranties of merchantability and fitness for a particular purpose, are hereby disclaimed. Some states/provinces do not allow limitations as to how long an implied warranty lasts or the exclusion or limitation of incidental or consequential damages, so the above limitations may not apply to you. This warranty gives you specific legal rights, and you may have other rights, which vary from state/province to state/province. Neither Clek Inc. nor the dealer selling this product has authorized any person to create for it any other warranty, obligation, or liability in connection with this product.

How To Receive Spanish Instructions

This instruction manual is also available in Spanish. To request a copy to be sent to you free of charge, please contact Clek Customer Service at 1-866-656-2462 or email us at customerservice@clekinc.com. You can also download a copy of the Olli instruction manual in Spanish online at: www.clekinc.com/support/olli/videos-and-manuals

Cómo recibir las instrucciones en español

Este manual de instrucciones también está disponible en español. Para pedir que se le envíe una copia sin cargo alguno, tenga a bien ponerse en contacto con el servicio al cliente de Clek, para lo cual llame al 1-866-656-2462 o envíe un mensaje de correo electrónico a customerservice@clekinc.com. También puede descargar una copia del manual de instrucciones de Olli en español por Internet en www.clekinc.com/support/olli/videos-and-manuals

Keep this Instruction Manual for future use.
Store the instruction manual in its pocket located on the bottom of the seat as shown.

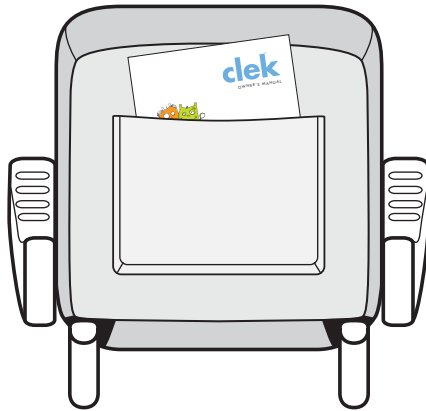

www.clekinc.com

Clek Inc.
226 Lesmill Road
Toronto, Ontario Canada
M3B 2T5
1-866-656-2462